

Installation Manual

Single Point Load Cell PR 55



Foreword

Must be followed!

Any information in this document is subject to change without notice and does not represent a commitment on the part of Minebea Intec unless legally prescribed. This product should only be operated/installed by trained and qualified personnel. In correspondence concerning this product, the type, name, and release number/serial number as well as all license numbers relating to the product have to be cited.

Note

This document is partially protected by copyright. It may not be changed or copied, and it may not be used without purchasing or written permission from the copyright owner (Minebea Intec). The use of this product constitutes acceptance by you of the abovementioned provisions.

Table of contents

1	Introduction	3
1.1	Read the manual	3
1.2	This is what operating instructions look like	3
1.3	This is what lists look like	3
1.4	This is what menu items and softkeys look like	3
1.5	This is what the safety instructions look like	3
1.6	Hotline	4
2	Safety instructions	5
2.1	General notes	5
2.2	Intended use	5
2.3	Initial inspection	5
2.4	Before operational startup	5
3	Specifications	6
3.1	Equipment supplied with the load cell	6
3.2	General information	6
3.3	Possible marking of the load cell for the Ex area	7
3.4	Dimensions	8
3.5	Ordering information	8
3.6	Technical data	9
4	Installation	11
4.1	Safety instructions	11
5	Connection	12
5.1	General information	12
5.2	Load cell	13
5.3	Load cell cable	13
5.4	Cable gland	14
6	Maintenance/repairs/cleaning	15
6.1	Maintenance	15
6.2	Repairs	15
6.3	Cleaning	15
7	Disposal	16
8	Certificates	17
8.1	CE-00052A	18
8.2	18-035	24
8.3	10103	26
8.4	R60/2000-A-NL1-18.02	27

8.5	TC11207.....	29
8.6	BVS 21 ATEX E 023X	32
8.7	IECEX BVS 21.0024X.....	40

1 Introduction

1.1 Read the manual

- Please read this manual carefully and completely before using the product.
- This manual is part of the product. Keep it in a safe and easily accessible location.

1.2 This is what operating instructions look like

1. - n. are placed before steps that must be done in sequence.
 - ▶ is placed before a step.
 - ▷ describes the result of a step.

1.3 This is what lists look like

- indicates an item in a list.

1.4 This is what menu items and softkeys look like

[] frame menu items and softkeys.

Example:

[Start]- [Applications]- [Excel]

1.5 This is what the safety instructions look like

Signal words indicate the severity of the danger involved when measures for preventing hazards are not followed.

DANGER

Warning of personal injury

DANGER indicates death or severe, irreversible personal injury which will occur if the corresponding safety measures are not observed.

- ▶ Take the corresponding safety precautions.

WARNING

Warning of hazardous area and/or personal injury

WARNING indicates that death or severe, irreversible injury may occur if appropriate safety measures are not observed.

- ▶ Take the corresponding safety precautions.

CAUTION

Warning of personal injury.

CAUTION indicates that minor, reversible injury may occur if appropriate safety measures are not observed.

- ▶ Take the corresponding safety precautions.

NOTICE**Warning of damage to property and/or the environment.**

NOTICE indicates that damage to property and/or the environment may occur if appropriate safety measures are not observed.

- ▶ Take the corresponding safety precautions.
-

Note:

User tips, useful information, and notes.

1.6 Hotline

Phone: +49.40.67960.444

Fax: +49.40.67960.474

eMail: help@minebea-intec.com

2 Safety instructions

2.1 General notes

NOTICE

Warning of damage to property and/or the environment.

The product was in perfect condition with regard to safety features when it left the factory.

- ▶ To maintain this condition and to ensure safe operation, the user must follow the instructions and observe the warnings in this manual.

2.2 Intended use

The load cells are designed for use in table scales, counting scales, and checkweighers.

The load cells PR 55 may only be used as intended for weighing tasks.

In intrinsically safe circuits, only load cells PR 55/..E may be used.

The dimensions of all mounting and structural components must be calculated so that sufficient overload capacity is ensured for all loads which may occur while taking the relevant standards into account. In particular, upright weighing objects must be safeguarded against the weighing installation turning over or being shifted, thus eliminating danger to people, animals, or goods even in the case of a break in a load cell or mounting element.

Installation and repair work must only be carried out by expert/qualified personnel.

The load cells reflect the state of the art. The manufacturer does not accept any liability for damage caused by third-party system components or due to incorrect use of the product.

2.3 Initial inspection

Check the contents of the consignment for completeness. Check the contents visually to determine whether any damage has occurred during transport. If there are grounds for rejection of the goods, a claim must be filed with the carrier immediately. The Minebea Intec sales or service organization must also be notified.

2.4 Before operational startup

NOTICE

Perform visual inspection.

- ▶ Before operational startup as well as after storage or transport, inspect the load cell visually for signs of mechanical damage.
- ▶ The load cell should not be commissioned if it displays signs of visible damage and/or is defective.

3 Specifications

3.1 Equipment supplied with the load cell

No.	Description
1	Load cell
2	Quick guide
3	Calibration Certificate
4	Only with Ex-load cells: Safety information for PR xx series

3.2 General information

Material	Stainless steel
Protection against environmental influences	Hermetically sealed by welding.
Protection classes	in compliance with IEC 529 or DIN EN 60529 IP68/IP69: Dust-proof and leak-tight against water, with harmful effects when immersed, (1.5 m water depth, 10,000 h) and water jets (high pressure and temperature). Explosion: Suitable for explosion subgroup IIC and IIIC.
EMC	High frequency electromagnetic fields acc. to EN 61000-4-3 10 V/m
Cable diameter	5 mm
Cable length	see data sheet
Cable gauge	6x0.14 mm ²
Cable bend radius	≥25 mm (fixed installation) ≥75 mm (flexible installation)
Cable sheath material	Thermoplastic elastomer (TPE)
Cable sheath color	Green, Ex version with blue marking
max. platform size in compliance with the technical data according to OIML R76	500 mm × 400 mm

3.3 Possible marking of the load cell for the Ex area

Zone	Marking	Certificate no.	for
0	II 1G Ex ia IIC T6/T4 Ga Ex ia IIC T6/T4 Ga	BVS 21 ATEX E 023 X IECEX BVS 21.0024 X	only PR 5x/..E
20	II 1D Ex ia IIIC T ₂₀₀ 165°C Da Ex ia IIIC T ₂₀₀ 165°C Da	BVS 21 ATEX E 023 X IECEX BVS 21.0024 X	only PR 5x/..E
2	II 3G Ex ec IIC T6/T4 Gc Ex ec IIC T6/T4 Gc	BVS 21 ATEX E 023 X IECEX BVS 21.0024 X	all PR 5x without /..E
21	II 2D Ex tb IIIC T110°C Db Ex tb IIIC T110°C Db	BVS 21 ATEX E 023 X IECEX BVS 21.0024 X	all PR 5x without /..E

NOTICE

Installation in the Ex area

- ▶ For installations in the Ex area, it is imperative to observe the Ex safety instructions in the installation manuals.

⚠ WARNING

Warning of hazardous area and/or personal injury

When used in a dust ex zone, the risk of electrostatic charging must be minimized.

- ▶ Dust layers on the load cell >5 mm are not permitted.
- ▶ The load cell must be installed securely.

3.4 Dimensions

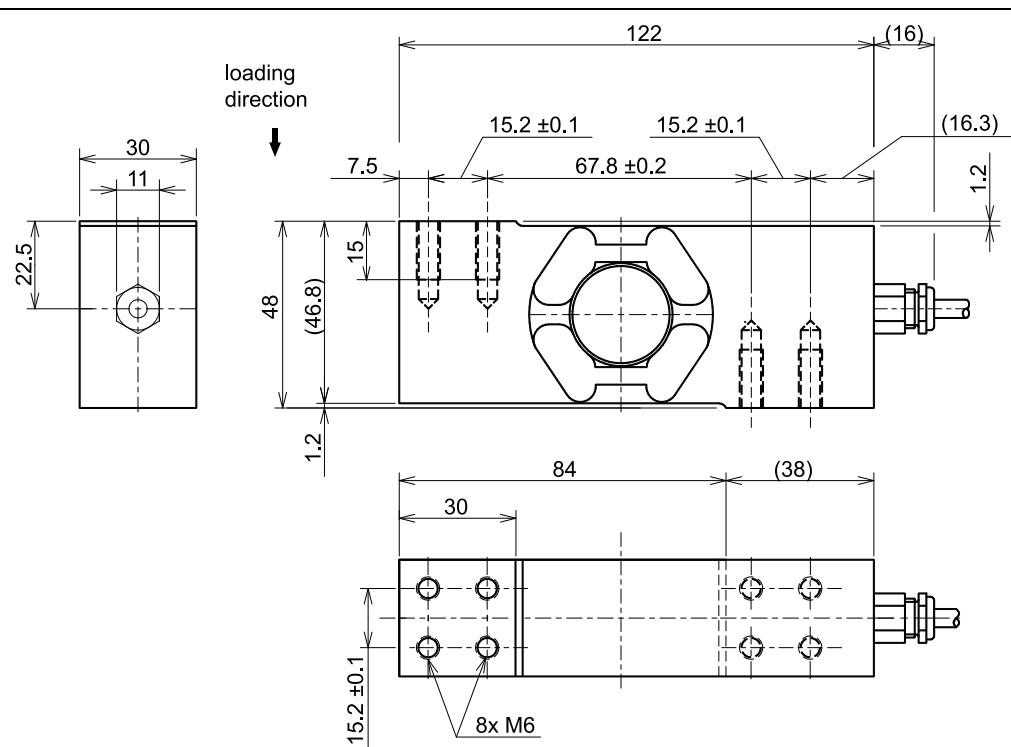

all dimensions in mm

3.5 Ordering information

Model	Max. capacity E_{max}	Type OIML	Type Ex	Type NTEP
PR 55/11 kg	11 kg	..C3MR	..C3MRE	..III5000S
PR 55/22 kg	22 kg	..C3MR	..C3MRE	..III5000S
PR 55/50 kg	50 kg	..C3MR	..C3MRE	..III5000S
PR 55/100 kg	100 kg	..C3MR	..C3MRE	..III5000S
PR 55/200 kg	200 kg	..C3MR	..C3MRE	..III5000S

3.6 Technical data

Designation	Description	Abbr.	C3MR	NTEP III 5000 Single	Unit
Accuracy class			0.02	0.014	% E _{max}
Minimum dead load	lowest limit of specified measuring range	E _{min}	0	0	% E _{max}
Maximum capacity	highest limit of specified measuring range	E _{max}	see Chapter 3.5		
Safe load limit	maximum load without irreversible damage	E _{lim}		150	% E _{max}
Destructive load	danger of mechanical destruction	E _d		300	% E _{max}
Minimum LC verification	minimum load cell scale interval, v _{min} = E _{max} /Y				
	PR 55/11 kg, PR 55/22 kg	Y		22000	
	PR 55/50 kg, PR 55/100 kg, PR 55/200 kg	Y		25000	
Minimum preload signal recurrence	recurrence of the minimum preload signal (DR = 1/2 × E _{max} /Z)	Z	3000	5000	
Rated output	relative output at maximum capacity	C _n		2	mV/V
Tolerance on rated output	permissible deviation from rated output C _n	d _c		<10	% C _n
Zero output signal	load cell output signal under unloaded condition	S _{min}		0 ±5	% C _n
Repeatability	max. change in load cell output for repeated loading	ε _R	<0.0100	<0.0070	% C _n
Creep	max. change of output signal at E _{max} during 30 minutes	d _{cr}	<0.0166	<0.0100	% C _n
Non-linearity ¹⁾	deviation from best straight line through zero	d _{Lin}	<0.0166	<0.0140	% C _n
Hysteresis ¹⁾	max. difference in LC output between loading and unloading	d _{hy}	<0.0166	<0.0140	% C _n
Temperature effect on S _{min}	max. change of S _{min} in B _T				
	PR 55/11 kg, PR 55/22 kg	TK _{Smin}		<0.0063	% C _n /10 K
	PR 55/50 kg, PR 55/100 kg, PR 55/200 kg	TK _{Smin}		<0.0056	% C _n /10 K
Temperature effect on C ¹⁾	max. change of C in B _T	TK _C	<0.0117	<0.0070	% C _n /10 K
Input impedance	between supply terminals	R _{LC}		1100 ±50	Ω
Output impedance	between measuring terminals	R _O		960 ±50	Ω

Designation	Description	Abbr.	C3MR	NTEP III 5000 Single	Unit
Insulation impedance	between measuring circuit and housing at $U_{DC} = 100\text{ V}$	R_{IS}		>5000	$M\Omega$
Insulation voltage	between circuit and housing			500	V
Recommended supply voltage	to hold the specified performance	B_u		≤ 12	V_{DC}
Max. supply voltage	permissible for continuous operation without damage	U_{max}		15	V_{DC}
Nominal ambient temp. range	to hold the specified performance	B_T		-10...+40	$^{\circ}C$
Usable ambient temp. range	permissible for continuous operation without damage	B_{Tu}		-30...+70	$^{\circ}C$
Storage temperature range	without electrical and mechanical stress	B_{Ti}		-50...+80	$^{\circ}C$
Barometric pressure influence	elastic deformation under maximum capacity			<0.004	% C_n/kPa
Nominal deflection	elastic deformation under maximum capacity	S_{nom}		<0.25	mm

1) The data for non-linearity (d_{Lin}), hysteresis (d_{hy}) and temperature effect on C (TKC) are typical values.
For OIML R60 or NTEP approved load cells the sum of these values is within the permissible cumulative error limits.

Definitions acc. to OIML R60

The technical data given are intended solely as a product description and should not be interpreted as guaranteed properties in the legal sense.

Accuracy classes and min. scale interval of the load cells v_{min}

PR 55	Type	Divisions n_{max}	11 kg	22 kg	50 kg	100 kg	200 kg	Unit
OIML	C3MR	3000	0.50	1.00	2.00	4.00	8.00	g
NTEP	Class III Single	5000	0.50	1.00	2.00	4.00	8.00	g

4 Installation

4.1 Safety instructions

NOTICE

Welding or lightning strike current flowing through the cell can damage it.

All electrical welding on the weighing system must be finished before mounting the load cells.

During any additional electrical welding work near the load cell:

- Disconnect the load cell cables.
- Bypass the load cell.
- Make sure that the grounding clamp of the welding set is fitted as closely as possible to the welding joint.

The following must be observed during installation:

- Do not lift or transport the load cell by pulling on the cable.
- Avoid shock stress (falling down, hard shocks).
- Load forces must act in the direction indicated (arrow on the load cell).

NOTICE

Changes of temperature >15 K/h may influence the measuring accuracy.

- ▶ Make sure to protect the load cells from direct heating or cooling effects (sun, wind, heat radiation, fan heaters), e.g., heat protection screens or heat protection housings are to be installed if necessary.

NOTICE

Force shunts may cause measuring errors.

- ▶ All incoming and outgoing lines (hoses, pipes, cables) must be coupled to the measured object as flexibly as possible.

5 Connection

5.1 General information

- Protect the cable ends against contamination. Moisture must not get into the open end of the cable.
- Keep the load cell cables away from power cables.
- The distance between measurement cables and power cables and/or components under high voltage should be at least 1 m (reference value).
- We recommend laying the load cell cables in separate cable trays or armored steel pipes.
- Power cables should be crossed at right angles while taking into account the minimum distance of 1 m (reference value).

Note:

If hum interference occurs, the cable screens should only be connected on one side.

Depending on the design of the cable junction box used, either the jumper J3 must be removed or the cable screens must be disconnected from the terminal contacts highlighted in yellow.

⚠ WARNING**When installing in potentially explosive atmospheres:**

It is imperative that you follow the application-dependent installation instructions!

- ▶ Always check whether it is permissible to bilaterally connect the screens to the equipotential bonding.
-

5.2 Load cell

Color code

bk	=	black
bu	=	blue
gn	=	green
gy	=	gray
rd	=	red
wh	=	white

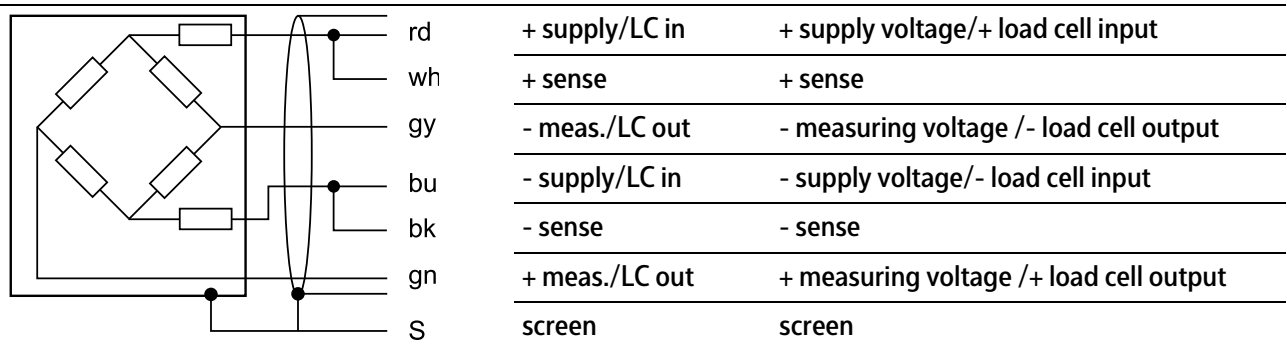

5.3 Load cell cable

The load cell cables are inseparably connected to the load cells in the factory.

The special sheathing material and the integrated strain relief with Kevlar thread ensure extremely long service life even under difficult operating conditions.

However, despite the robust nature of the materials used, the cable should be protected from excessive chemical and mechanical stresses. Preventing water from penetrating the end of the cable is also important "life insurance" for the system.

5.4 Cable gland

The cable gland is screwed to the load cell.

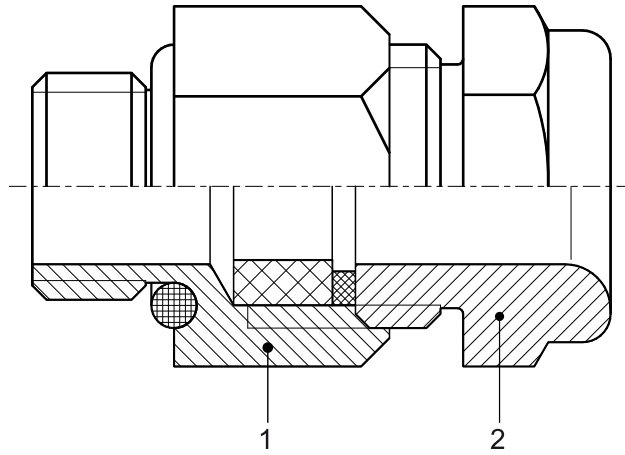

1. Screw the metal sleeve (1) into the load cell and fasten with a tightening torque of 3 Nm.
2. Screw the nut (2) into the metal sleeve and fasten with a tightening torque of 3 Nm.

6 Maintenance/repairs/cleaning

6.1 Maintenance

The load cells PR 55 are maintenance-free.

6.2 Repairs

The load cells PR 55 are designed to be robust as possible for the required measuring accuracy and are highly reliable.

Should an electrical or mechanical defect nevertheless occur, the load cell must be replaced.

Load cell repair is not possible.

6.3 Cleaning

Dirt on the load cell and movable parts of the scale must be cleaned as quickly as possible

- if it influences weighing, or
- if it is corrosive to the cell or cable material.

NOTICE

Some cleaning agents may not be compatible with the load cell material.

- ▶ When using cleaning agents, ensure that their compatibility with the load cell material has been tested and approved (see Chapter [3.2](#)).

Clean the load cell with a damp cloth to avoid electrostatic charging.

7 Disposal

Our products and their packaging should not be disposed of in municipal waste (e.g. garbage can for recyclable packaging, garbage can for paper packaging, etc.). They can either be recycled by the customer themselves, providing this complies with requirements set out by electrical or electronic waste or packaging waste laws, or sent back to Minebea Intec at a charge.

This option of returning the product is intended to provide proper recycling or reuse in a manner that is collected separately from municipal waste.

Before disposing of or scrapping the old products, any single-use or rechargeable batteries should be removed and taken to a suitable collection point. The type of battery used is specified in the technical data.

Please see our General Terms and Conditions for further information.

Service addresses for repair acceptance and collection points can be found on the product information enclosed with the product as well as on our website (www.minebea-intec.com).

Should you have any further questions, please contact your local service representative or our service center.

Minebea Intec GmbH

Repair center

Meiendorfer Strasse 205 A

22145 Hamburg, Germany

Phone: +49.40.67960.333

service.HH@minebea-intec.com

We reserve the right not to accept products that are contaminated with hazardous substances (ABC contamination).

8 Certificates

Ser. no.	Description	Document no.	see Chapter
1	EU-Declaration of Conformity	CE-00052A	8.1
2	Certificate of Conformance (NTEP)	18-035	8.2
3	Certificate of Approval (NTEP-New York)	10103	8.3
4	OIML Certificate of Conformity (NMI)	R60/2000-A-NL1-18.02	8.4
5	Parts Certificate/Test Certificate (NMI)	TC11207	8.5
6	EC-Type Examination Certificate	BVS 21 ATEX E 023X	8.6
7	Certificate of Conformity	IECEX BVS 21.0024X	8.7

8.1 CE-00052A



CE-00052A

EU-Declaration of Conformity



Passion to Create Value through Difference

1. Product model / product number:

	Single Point Type Load Cell / PR 55, M080
--	---

2. Name and address of the manufacturer (2.1) and his authorized representative (2.2):

2.1	MinebeaMitsumi Inc. Sensing Device Business Unit, 1-1-1 Katase, Fujisawa-shi, Kanagawa, Japan
2.2	/

3. This declaration of conformity is issued under the sole responsibility of the manufacturer.

4. Object(s) of the declaration:

4.1	PR 55-***** M080-*****N***
4.2	PR 55-***** (A.1) M080-*****2***
4.3	PR 55-*****E M080-*****0***

5. The object(s) of the declaration described above is in conformity with the relevant Union harmonization legislation:

	(4.1)	(4.2)	(4.3)
5.1	2014/30/EU	(6.1)	(6.1)
5.2	2011/65/EU	(6.2)	(6.2)
5.3	2014/34/EU	(6.3)	(6.4)

6. References to the relevant harmonized standards used or references to the other technical specifications in relation to which conformity is declared:

6.1	2014/30/EU	EN 61326-1:2013
6.2	2011/65/EU	EN IEC 63000:2018
6.3	2014/34/EU	EN IEC 60079-0:2018, EN IEC 60079-7:2015+A1:2018, EN 60079-31:2014
6.4	2014/34/EU	EN IEC 60079-0:2018, EN 60079-11:2012

7. The notified body w performed x and issued the certificate y relevant for z:

	w	x	y	z
7.1	0158	EU-Type Examination Certificate	BVS 21 ATEX E 023 X	(4.2)(4.3)
7.2	0344	Production Quality Assessment Notification	DEKRA 17ATEXQ0031	(4.2)(4.3)

MinebeaMitsumi Inc.
Fujisawa, 15. November. 2021



Satoshi Sato
Division Head

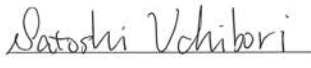

Satoshi Uchibori
CE Certification

1/6



EU-Declaration of Conformity

MinebeaMitsumi
Passion to Create Value through Difference

A. Additional information on ():

A.1 (4.2) Marking



II 3G Ex ec IIC T6/T4 Gc
 II 2D Ex tb IIIC T110°C Db
 BVS 21 ATEX E 023 X

A.2 (4.3) Marking



II 1G Ex ia IIC T6/T4 Ga
 II 1D Ex ia IIIC T₂₀₀ 165°C Da
 BVS 21 ATEX E 023 X



EU-Declaration of Conformity



български (bg)

Декларация за съответствие
 1. Модел на продукта / Номер на продукта / илустрация само за номера на проекта:
 2. Именното и адрес на производителя (2.1) и на неговия упълномощен представител (2.2):
 3. Настоящата декларация за съответствие е издадена на отговорността на производителя.
 4. Предмет(и) на декларацията:
 5. Предмет(и) на декларацията, описан(и) по-горе отговаря(т) на съответното законодателство на Съюза за хармонизиране:
 6. Позоваване на използваните хармонизираните стандарти или позоваване на други технически спецификации, по отношение на които се декларира съответствие:
 7. Нотифицираният орган в извършил и издал сертификата Y, отнасящ се за:
 A. Допълнителна информация за (:)
 A.1 Маркировка
 A.2 Маркировка

čeština (cs)

Prohlášení o shodě
 1. Model výrobku / číslo výrobku / platné pouze pro číslo projektu:
 2. Jméno a adresa výrobce (2.1) a jeho zplnomocněného zástupce (2.2):
 3. Toto prohlášení o shodě se vydává na výhradní odpovědnost výrobce.
 4. Předmět(y) prohlášení:
 5. Výše popsaný předmět / Výše popsané předměty prohlášení je/ jsou ve shodě s příslušnými harmonizačními právními předpisy Unie:
 6. Odkazy na příslušné harmonizované normy, které byly použity, nebo na jiné technické specifikace, na jejichž základě se shoda prohlašuje:
 7. Oznamovaný subjekt v provedl x a vydal certifikát y relevantní z hlediska z:
 A. Další informace o (:)
 A.1 Označení
 A.2 Označení

dansk (da)

Overensstemmelseserklæring
 1. Produktmodel / produktnummer / gælder kun for projektnummer:
 2. Fabrikantens (2.1) og dennes bemyndigede repræsentants (2.2) navn og adresse:
 3. Denne overensstemmelseserklæring udstedes på fabrikantens ansvar.
 4. Genstand(ene) for erklæringen:
 5. Genstand(ene) for erklæringen, som beskrevet ovenfor, er i overensstemmelse med den relevante EU-harmoniseringslovgivning:
 6. Referencer til de relevante anvendte harmoniserede standarder eller til de andre tekniske specifikationer, som der erklæres overensstemmelse med:
 7. Det bemyndigede organ har foretaget x og udstedt attesten y, der gælder for z:
 A. Supplerende oplysninger om (:)
 A.1 Markering
 A.2 Markering

Deutsch (de)

Konformitätserklärung
 1. Produktmodell / Produktnummer / gilt ausschließlich für Projekt-Nr.:
 2. Name und Anschrift des Herstellers (2.1) und seines Bevollmächtigten (2.2):
 3. Die alleinige Verantwortung für die Ausstellung dieser Konformitätserklärung trägt der Hersteller.
 4. Gegenstände der Erklärung:
 5. Die oben beschriebenen Gegenstände der Erklärung erfüllen die einschlägigen Harmonisierungsrechtsvorschriften der Union:
 6. Angabe der einschlägigen harmonisierten Normen oder der anderen technischen Spezifikationen, die der Konformitätserklärung zugrunde gelegt wurden:
 7. Die notifizierte Stelle w hat x und die für z relevante Bescheinigung y ausgestellt:
 A. Zusatzangaben zu (:)
 A.1 Kennzeichnung
 A.2 Kennzeichnung

Ελληνικά (el)

Δήλωση συμμόρφωσης
 1. Μοντέλο προϊόντος / αριθμός προϊόντος / ισχύει μόνο για τον αριθμό του έργου:
 2. Όνομα και διεύθυνση του κατασκευαστή (2.1) και του εξουσιοδοτημένου εκπροσώπου του (2.2):
 3. Η παρούσα δήλωση συμμόρφωσης εκδίδεται με αποκλειστική ευθύνη του κατασκευαστή.
 4. Στόχος της δήλωσης:
 5. Ο στόχος της δήλωσης που περιγράφεται παραπάνω είναι σύμφωνος με τη σχετική ενοποιηκή νομοθεσία ενωμένης:
 6. Παραπομπές στα σχετικά εναρμονισμένα πρότυπα που χρησιμοποιήθηκαν ή παραπομπές στις λοιπές τεχνικές προδιαγραφές σε σχέση με τις οποίες δηλώνεται η συμμόρφωση:
 7. Ο κοινοποιημένος οργανισμός w διέκρινε x και εξέδωσε το πιστοποιητικό y όπως απαιτείται για z:
 A. Πρόσθετες πληροφορίες σχετικά με (:)
 A.1 Σήμανση
 A.2 Σήμανση

español (es)

Declaración de conformidad
 1. Modelo de producto/número de producto / únicamente válido para el número de proyecto:
 2. Nombre y dirección del fabricante (2.1) y de su representante autorizado (2.2):
 3. La presente declaración de conformidad se expide bajo la exclusiva responsabilidad del fabricante.
 4. Objeto(s) de la declaración:
 5. El/Los objeto(s) de la declaración descritos anteriormente son conformes con la legislación de armonización pertinente de la Unión Europea:
 6. Referencias a las normas armonizadas pertinentes utilizadas o referencias a las otras especificaciones técnicas respecto a las cuales se declara la conformidad:
 7. El organismo notificado W ha efectuado X y expedido el certificado Y relevante para Z:
 A. Información adicional en (:)
 A.1 Marcado
 A.2 Marcado



EU-Declaration of Conformity

MinebeaMitsumi
Passion to Create Value through Difference

cești keel (et)

Vastavusdeklaratsioon
1. Tootemudel / tootenumber / kehüb vaid järgmise projekti puhul:
2. Tootja nimi ja aadress (2.1) ning tema volitatud esindaja (2.2);
3. Käesolev vastavusdeklaratsioon on välja antud tootja ainuvastutusel.
4. Deklareeritava toode:
5. Üllalrijeldatud deklareeritava toode on kooskõlas asjaomaste liidu ühtlustamisaktidega;
6. Viited kasutatud harmoneeritud standarditele või viited muudele tehnilistele spetsifikatsioonidele, millele vastavust deklareeritakse:
7. Teavitatud asutus w teostas x ja andis välja tõendi z, mis on asjakohane y-le:
A. Lisateave järgmise kohta ():
A.1 Märgistus
A.2 Märgistus

français (fr)

Déclaration de conformité
1. Modèle / numéro de produit / valable uniquement pour le numéro de projet:
2. Nom et adresse du fabricant (2.1) et de son mandataire (2.2);
3. La présente déclaration de conformité est établie sous la seule responsabilité du fabricant.
4. Objet(s) de la déclaration:
5. Le ou les objets de la déclaration débite existants est(sont) conformet(s) à la législation d'harmonisation de l'Union applicable;
6. Références des normes harmonisées pertinentes appliquées ou des autres spécifications techniques par rapport auxquelles la conformité est déclarée;
7. L'organisme notifié w a effectué x et a établi l'attestation y applicable à z:
A. Informations complémentaires relatives à ():
A.1 Marquage
A.2 Marquage

hrvatski (hr)

Izjava o sukladnosti
1. Model proizvoda / broj proizvoda / vrijedi samo za broj projekta:
2. Naziv i adresa proizvođača (2.1) i njegovog ovlaštenog zastupnika (2.2);
3. Za izdavanje ove izjave o sukladnosti odgovoran je isključivo proizvođač.
4. Predmet(i) izjave:
5. Predmet(i) navedene izjave je/su u skladu s njerodavnim zakonodavstvom Unije o usklađivanju;
6. Pozivanja na relevantne priložene usklađene norme ili pozivanja na ostale tehničke specifikacije u vezi s kojima se izjavljuje sukladnost;
7. Prijavljeno tijelo w provelo je x i izdalo certifikat y koji je relevantan za z:
A. Dodatne informacije o proizvodu ();
A.1 Označavanje
A.2 Označavanje

magyar (hu)

Megfelelőségi nyilatkozat
1. Termékmódel / termékszám / kizárólag az alábbi projektszámhoz érvényes:
2. A gyártó (2.1) vagy adott esetben meghatalmazott képviselőjének (2.2) neve és címe:
3. Ezt a megfelelőségi nyilatkozatot a gyártó kizárólagos felelőssége mellett adják ki.
4. A nyilatkozat tárgya(i):
5. A fent ismertetett nyilatkozat tárgya megfelel a vonatkozó uniós harmonizációs jogszabályoknak;
6. Az alkalmazott harmonizált szabványokra való hivatkozás vagy az azokra az egyéb műszaki leírásokra való hivatkozás, amelyekkel kapcsolatban megfelelőségi nyilatkozatot tettek;
7. A(z) w bejelentett szervezet elvégzte a(z) x eljárást, és kiállította a(z) z kapcsolódó y tanúsítványt:
A. További információk ():
A.1 Jelölés
A.2 Jelölés

italiano (it)

Dichiarazione di conformità
1. Modello di prodotto / numero di prodotto / valido unicamente per numero di progetto:
2. Nome e indirizzo del fabbricante (2.1) e del relativo rappresentante autorizzato (2.2);
3. La presente dichiarazione di conformità è rilasciata sotto la responsabilità esclusiva del fabbricante.
4. Oggetto/i della dichiarazione:
5. L'oggetto o gli oggetti della dichiarazione di cui sopra sono conformi alla pertinente normativa di armonizzazione dell'Unione;
6. Riferimento alle pertinenti norme armonizzate utilizzate o riferimenti alle altre specifiche tecniche in relazione alle quali è dichiarata la conformità;
7. L'organismo notificato w ha effettuato x e rilasciato il certificato y pertinente a z:
A. Informazioni aggiuntive su ():
A.1 Marcatura
A.2 Marcatura

Latvian kalba (lv)

Atbilstības deklarācija
1. Ģaminio modelis / ģaminio numeris / galioja tikai projekto numerim:
2. Ģaminiojo (2.1) ir jo ģgaliojojo atstovo (2.2) pavadināmas ir adresās:
3. Ši atbilstības deklarācija izdojta tikai ģaminiojojo atsakomybe.
4. Deklarācijas objekts (objekti):
5. Pirmāra aprašytais deklarācijas objekts (objekti) atbilst sasyjusytais derināmosytais Sasyjungos teisis aktytais:
6. Susyjusytais atbilstytais derināmytais standartu mūrodos arba kityu tehnisytais specifikāciju, pagal kurās byvo deklarāta atbilstis, mūrodos;
7. Notifytais notytais ystaga w atliko x ir isdāve serityfikāty dēly z:
A. Papildoma informācija ():
A.1 Zēnklināmas
A.2 Zēnklināmas



EU-Declaration of Conformity

MinebeaMitsumi
Passion to Create Value through Difference

latviešu valoda (lv)

Athibstības deklarācija

1. Produkta modeļa / produkta numurs / derīgā tikai projektam Nr.:
2. Ražotāja (2.1.) un tā pilnvarotā pārstāvja (2.2.) nosaukums un adrese:
3. Šī atbilstības deklarācija ir izdota vienīgi uz ražotāja atbildību.
4. Deklarācijas priekšmets vai priekšmeti:
5. Iepriekš aprakstītais deklarācijas priekšmets vai priekšmeti atbilst attiecīgajam Savienības saskaņošanas tiesību aktam:
6. Atsaucies uz attiecīgajiem izmantojamiem saskaņotajiem standartiem vai uz citām tehniskajām specifikācijām, attiecībā uz ko tiek deklarēta atbilstība:
7. Paziņotā struktūra w ir veikusi x un izsniegusi sertifikātu y, kas attiecas uz z:

A. Papildu informācija par ():

- A.1. Marķējums
A.2. Marķējums

malta (mt)

Dikjarazzjoni ta' konformità

1. Modell tal-prodott / numru tal-prodott / valida biss għan-numru tal-proġett:
2. L-isem u l-indirizz tal-manifattur (2.1) u tarappreżentant awtorizzat tiegħu (2.2):
3. Din id-dikjarazzjoni ta' konformità tinfahreg taħt ir-responsabbiltà unika tal-manifattur.
4. L-għan(jiet) tad-dikjarazzjoni:
5. L-għan(jiet) tad-dikjarazzjoni deskritt(i) haqqa fuq luwa(gh)ma konformi mal-legislazzjoni ta' armonizzazzjoni rilevanti tal-Unjoni:
6. Ir-referenzi għall-istandards armonizzati rilevanti li ntuzaw, jew ir-referenzi għallspeċifikazzjonijiet tekniċi l-oħra li skonthom qed tiġi ddikjarata l-konformità:
7. Il-korp notifikat w wettaq x u hareġ iċertifikat y rilevanti għal z:

A. Informazzjoni addizzjonali fuq ():

- A.1. Immarkar
A.2. Immarkar

nederlands (nl)

Conformiteitsverklaring

1. Productmodel / productnummer / uitsluitend geldig voor projectnummer:
2. Naam en adres van de fabrikant (2.1) en zijn gemachtigde (2.2):
3. Deze conformiteitsverklaring wordt verstrekt onder volledige verantwoordelijkheid van de fabrikant.
4. Voorwerp(en) van de verklaring:
5. Het (de) hierboven beschreven voorwerp(en) is (zijn) in overeenstemming met de desbetreffende harmonisatiewetgeving van de Unie:
6. Vermelding van de toegepaste relevante geharmoniseerde normen of van de overige technische specificaties waarop de conformiteitsverklaring betrekking heeft:
7. De aangemelde instantie w heeft een x uitgevoerd en het certificaat y verstrekt dat relevant is voor z:

A. Aanvullende informatie over ():

- A.1. Markering
A.2. Markering

polski (pl)

Deklaracja zgodności

1. Model produktu / numer produktu / ważny wyłącznie dla projektu o numerze:
2. Nazwa i adres producenta (2.1) oraz jego upoważnionego przedstawiciela (2.2):
3. Niniejsza deklaracja zgodności wydana zostaje na wyłączną odpowiedzialność producenta.
4. Przedmiot(-y) deklaracji:
5. Wymagania powyżej przedmiot (lub przedmiotów) niniejszej deklaracji jest zgodny z odpowiednimi wymaganiami unijnego prawodawstwa harmonizacyjnego:
6. Odwołania do odpowiednich norm zharmonizowanych, które zastosowano, lub do innych specyfikacji technicznych, w stosunku do których deklarowana jest zgodność:
7. Jednostka notyfikowana w przeprowadziła x i wydała certyfikat y i odpowiedni dla z:

A. Informacje dodatkowe o ():

- A.1. Oznakowanie
A.2. Oznakowanie

português (pt)

Declaração de conformidade

1. Modelo do produto / número do produto / somente válido para o número de projeto:
2. Nome e endereço do fabricante (2.1) e do seu mandatário (2.2):
3. A presente declaração de conformidade é emitida sob a exclusiva responsabilidade do fabricante.
4. Objeto(s) da declaração:
5. O(s) objeto(s) da declaração acima descrito(s) está(ão) em conformidade com a legislação aplicável de harmonização da União:
6. Referências às normas harmonizadas aplicáveis utilizadas ou às outras especificações técnicas em relação às quais é declarada a conformidade:
7. O organismo notificado w realizou x e emitiu o certificado y relevante para z:

A. Informações complementares relativa a ():

- A.1. Marcação
A.2. Marcação

română (ro)

Declarație de conformitate

1. Modelul de produs / Număr produs / valabil numai pentru numărul proiectului:
2. Denumirea și adresa producătorului (2.1) și a reprezentantului său autorizat (2.2):
3. Prezenta declarație de conformitate este emisă pe răspunderea exclusivă a producătorului.
4. Obiectul (obiectele) declarației:
5. Obiectul (obiectele) declarației descrise mai sus sunt în conformitate cu legislația relevantă de armonizare a Uniunii:
6. Trimiteri la standardele armonizate relevante folosite sau trimiteri la edelalte specificații tehnice în legătură cu care se declară conformitatea:
7. Organismul notificat w a efectuat x și a emis certificatul y corespunzător pentru z:

A. Informații suplimentare despre ():

- A.1. Marcaj
A.2. Marcaj



EU-Declaration of Conformity

MinebeaMitsumi
Passion to Create Value through Difference

slovenčina (sk)

Vyhlasenie o zhode
1. Model výrobku / číslo výrobku / platné len pre číslo projektu:
2. Meno/názov a adresa výrobcu (2.1) a jeho splnomocneného zástupcu (2.2):
3. Toto vyhlásenie o zhode sa vydáva na vlastnú zodpovednosť výrobcu.
4. Predmet(-y) vyhlásenia:
5. Uvedený predmet si uvedení predmety vyhlásenia sú v zhode s príslušnými harmonizačnými právnymi predpismi Únie:
6. Odkazy na príslušné použité harmonizované normy alebo odkazy na iné technické špecifikácie, v súvislosti s ktorými sa zhoda vyhlasuje:
7. Notifikovaný orgán v vykonal x a vydal certifikát y relevantný pre z:
A. Doplnujúce informácie o ():
A.1 Označenie
A.2 Označenie

slovenščina (sl)

Izjava o skladnosti
1. Model proizvoda / serijska številka proizvoda / veljavno samo za številko projekta:
2. Ime in naslov proizvajalca (2.1) ter njegovega pooblaščenega zastopnika (2.2):
3. Za izdajo te izjave o skladnosti je odgovoren izključno proizvajalec.
4. Predmet(i) izjave:
5. Predmet(i) navedene izjave je (so) v skladu z ustrežno zakonodajo Unije o harmonizaciji:
6. Sklicevanja na uporabljene ustrezne harmonizirane standarde ali sklicevanja na druge tehnične specifikacije v zvezi s skladnostjo, ki je navedena v izjavi:
7. Priglaseni organ w je izvedel x in izdal certifikat y, pomemben za z:
A. Dodatne informacije o ():
A.1 Oznaka
A.2 Oznaka





suomi (fi)

Vaatimustenmukaisuusvakuutus
1. Tuotemalli / tuotenumero / koskee vain projektinumeroa:
2. Valmistajan (2.1) ja valtuutetun edustajan (2.2) nimi ja osoite:
3. Tämä vaatimustenmukaisuusvakuutus on annettu valmistajan yksinomaisella vastuulla.
4. Vakuutuksen kohde (kohdet):
5. Edellä kuvattu (kuvattu) vakuutuksen kohde (kohdet) on (ovat) asiaa koskevan unionin yhdenmukaistamisäätämön vaatimusten mukainen (mukaisia):
6. Viittaus niihin asiaan koskeviin yhdenmukaistettuihin standardeihin, joita on käytetty, tai viittaus muihin tekniisin eritelmiin, joiden perusteella vaatimustenmukaisuusvakuutus on annettu:
7. Ilmoitettu laitos w suoritti x ja antoi todistuksen y liityen z:
A. Lisä tietoja ():
A.1 Merkintä
A.2 Merkintä

svenska (sv)

Försäkran om överensstämmelse
1. Produktmodell / produktnummer / gäller endast för projektnummer:
2. Tillverkarens namn och adress (2.1) och dess auktoriserade representant (2.2):
3. Denna försäkran om överensstämmelse utfärdas på tillverkarens eget ansvar.
4. Föremål för försäkran:
5. Föremålet/föremålen för försäkran ovan överensstämmer med den relevanta harmoniserade unionslagstiftningen:
6. Hänvisningar till de relevanta harmoniserade standarder som använts eller hänvisningar till de andra tekniska specifikationer enligt vilka överensstämmelsen försäkras:
7. Det anmälda organet w har utfört x och utfärdat intyget y relevant för z:
A. Ytterligare information om ():
A.1 Märkning
A.2 Märkning

8.2 18-035

 		Certificate Number: 18-035 Page 1 of 2
NATIONAL TYPE EVALUATION PROGRAM <i>Certificate of Conformance</i> <i>for Weighing and Measuring Devices</i>		
For: Load Cell Compression Model: M080 & PR55 Series n_{max} : 5000, Class III, Single Cell Capacity: 11 kg to 200 kg Accuracy Class: III	Submitted By: MinebeaMitsumi Inc. 1-1-1, Katase Fujisawa, Kanagawa 251-8531 Japan Tel: +81 (0) 466 22 7152 Fax: +81 (0) 466 22 1701 Contact: Mr. Katsumi Shibasaki Email: kshibasaki@minebeamitsumi.com Web site: www.minebea-mcd.com	
Standard Features and Options		
<ul style="list-style-type: none"> • The specific load cell models, capacities and v_{min} values covered by this Certificate are listed in the table on Page 2. • Nominal output: 2.0 mV/V • Stainless Steel • 6 Wire Design • Minimum Dead Load: 0 kg 		
Temperature Range: -10 °C to 40 °C (14 °F to 104 °F)		
This device was evaluated under the National Type Evaluation Program and was found to comply with the applicable technical requirements of "NIST Handbook 44: Specifications, Tolerances and Other Technical Requirements for Weighing and Measuring Devices." Evaluation results and device characteristics necessary for inspection and use in commerce are on the following pages.		
 James Cassidy Chairman, NCWM, Inc.	 Kristin Macey Chairman, National Type Evaluation Program Committee Issued: March 27, 2018	
1135 M Street, Suite 110 / Lincoln, Nebraska 68508		
The National Conference on Weights and Measures (NCWM) does not approve, recommend or endorse any proprietary product or material, either as a single item or as a class or group. Results shall not be used in advertising or sales promotion to indicate explicit or implicit endorsement of the product or material by the NCWM.		



Certificate Number: 18-035
Page 2 of 2

MinebeaMitsumi Inc.

Load Cell / M080 & PR55 Series

Application: The load cells may be used in Class III scales for single cell applications consistent with the model designations, number of scale divisions, and parameters specified in this certificate. Load cells of a given accuracy class may be used in applications with lower accuracy class requirements provided the number of scale divisions, the v_{\min} value, and temperature range are suitable for the application. The manufacturer may market the load cell with fewer divisions (n_{\max}) and with greater v_{\min} values than those listed on the certificate. However, the load cells must be marked with the appropriate n_{\max} and v_{\min} for which the load cell may be used.

Specific Capacities and v_{\min} Values:

Models	Capacity	v_{\min} Class III Single Cell, n = 5000
M080 and PR55 Series * load cell tested	11 kg*	0.45 g
	22 kg	0.89 g
	50 kg*	2.0 g
	100 kg	4.0 g
	200 kg	8.0 g

Identification: A pressure sensitive identification label located on the cell, states manufacturer name, model, serial number, NTEP Certificate number and rated capacity. Other pertinent information will be specified on the Calibration Certificate accompanying the cell.

Test Conditions: A 11 kg and 50 kg capacity load cell were tested by the NMI Certain B.V. at The Netherlands facility. Testing was conducted in accordance with the OIML-CS, signed by the NCWM as a utilizer participant for load cell testing. Testing was conducted using deadweights as the reference standard. The load cells were tested over a temperature range of -10 °C to 40 °C with tests run on each cell at each temperature. The temperature effect on zero was measured and a time dependence (creep) test was performed. The barometric pressure test to determine sensitivity of the load cell design to changes in barometric pressure was conducted. The data were analyzed for single load cell applications. OIML R60 selection criteria were used to determine cells tested.

Evaluated By: S.J. Koeman, E. M.M.J. Meijer (NMI)

Type Evaluation Criteria Used: NIST, Handbook 44: Specifications, Tolerances and Other Technical Requirements for Weighing and Measuring Devices, 2018. NCWM, Publication 14: Weighing Devices, 2018.

Conclusion: The results of the evaluation and information provided by the manufacturer indicate the device complies with applicable requirements.

Information Reviewed By: J. Truex (NCWM)

Example of Device:



8.3 10103



10B Airline Drive
Albany, New York 12235
800-554-4501
www.agriculture.ny.gov

Certificate of Approval
for Weighing and Measuring Devices

New York State Certificate Number: 10103
Effective Date: April 27, 2018

NTEP Certificate of Conformance Number: 18-035

For:
Load Cell
Compression
Model: M080 & PR55 Series
 F_{max} : 5000, Class III, Single Cell
Capacity: 11 kg to 200 kg
Accuracy Class: III

Submitted By:
MinebeaMitsumi Inc.
1-1-1, Katase
Fujisawa, Kanagawa 251-8531
Japan
Tel: +81 (0) 466 22 7152
Fax: +81 (0) 466 22 1701
Contact: Mr. Katsumi Shibasaki
Email: kshibasaki@minebeamitsumi.com
Web site: www.minebea-mcd.com

This certifies that the items specified in the above National Type Evaluation Program (NTEP) Certificate of Conformance are hereby approved for sale or use in the State of New York.

The NTEP Certificate of Conformance, as issued by the National Conference on Weights and Measures, is accepted under the terms of INYCRR Part 220.1. Evaluation results and device characteristics necessary for inspection and use in commerce are stated in the NTEP Certificate of Conformance. Copies of the NTEP Certificate of Conformance are available on request and are available for inspection at the Bureau's Metrology Office at 6 Harriman Campus Road, Albany, NY 12206.

A handwritten signature in black ink, appearing to read "Michael Sikula".

Michael Sikula, Director
NYS Bureau of Weights and Measures

WM-23 (rev. 02/15) Duplicate Original

NTEP

8.4 R60/2000-A-NL1-18.02

		OIML Certificate	
OIML Member State The Netherlands		Number R60/2000-A-NL1-18.02 Project number 1902088 Page 1 of 2	
Issuing authority	NMI Certin B.V. Person responsible: C. Oosterman		
Applicant and Manufacturer	MinebeaMitsumi Inc. 1-1-1, Katase Fujisawa-shi, Kanagawa-ken 251-8531 Japan		
Identification of the certified type	A single point load cell , with strain gauges Type : M080 or PR55		
Characteristics	See next page		
This OIML Certificate is issued under scheme A.			
This Certificate attests the conformity of the above identified Type (represented by the sample(s) identified in the OIML Test Report) with the requirements of the following Recommendation of the International Organization of Legal Metrology (OIML):			
OIML R 60 - Edition 2000 (E) for accuracy class C			
This Certificate relates only to the metrological and technical characteristics of the type of measuring instrument covered by the relevant OIML International Recommendation above-identified. This Certificate does not bestow any form of legal international approval.			
<i>Important note:</i> Apart from the mention of the Certificate's reference number and the name of the OIML Member State in which the Certificate was issued, partial quotation of the Certificate and of the associated OIML Test Report(s) is not permitted, although either may be reproduced in full.			
Issuing Authority	NMI Certin B.V., OIML Issuing Authority NL1 13 March 2018		
	 C. Oosterman Head Certification Board		
NMI Certin B.V. Hugo de Grootplein 1 3314 EG Dordrecht the Netherlands T +31 78 6332332 certin@nmi.nl www.nmi.nl	This document is issued under the provision that no liability is accepted and that the applicant shall indemnify third-party liability.		
	The notification of NMI Certin B.V. as Issuing Authority can be verified at www.oiml.org		



OIML Certificate

OIML Member State
The Netherlands

Number R60/2000-A-NL1-18.02
Project number 1902088
Page 2 of 2

The conformity was established by the results of tests and examinations provided in the associated OIML Test Reports:

- No. NMI-1902088-01 dated 13 March 2018 that includes 51 pages;
- No. NMI-1902088-02 dated 13 March 2018 that includes 46 pages.

Characteristics of the load cell:

Maximum capacity (E_{max})	11 kg up to 50 kg	50 kg up to and including 200 kg
Minimum dead load	0 kg	
Accuracy Class	C	
Rated Output	2,0 mV/V	
Maximum number of load cell intervals (n) ⁽¹⁾	3000	
Ratio of minimum LC Verification interval ⁽¹⁾ $Y = E_{max} / V_{min}$	24700	25000
Ratio of minimum dead load output return ⁽¹⁾ $Z = E_{max} / (2 * DR)$	7500	
Input impedance	1100 $\Omega \pm 50 \Omega$	
Temperature range	-10 °C / + 40 °C	
Fraction p_{LC}	0,7	
Humidity Class	CH	
Safe overload	150 % of E_{max}	
Output impedance	960 $\Omega \pm 50 \Omega$	
Recommended excitation	10 V AC / DC	
Excitation maximum	15 V AC / DC	
Transducer material	Stainless steel	
Atmospheric protection	Hermetically welded	

Remark:

1. The characteristics for n_{max} , Y and Z can be reduced separately.

Each load cell produced is provided with an accompanying document with information about its characteristics.

The above identified Type (represented by the sample(s) identified in the OIML Test Report) have been found to comply with the additional national requirements established by the United States of America (NIST Handbook 44 and NCWM Publication 14), included in the Utilizer Declaration:

- R 60 OIML-CS rev.2 Additional requirements from the United States Accuracy class III L;
- R 60 OIML-CS rev.2 Additional requirements from the United States Marking requirements.

8.5 TC11207

	<h2 style="text-align: center;">Test Certificate Parts Certificate</h2>
	<p style="text-align: right;">Number TC11207 revision 0 Project number 1902088 Page 1 of 1</p>
Issued by	NMI Certin B.V.
In accordance with	WELMEC 8.8 Issue 2, WELMEC 2.4 Issue 2, OIML R 60 (2000), EN 45501:2015.
Producer	MinebeaMitsumi Inc. 1-1-1, Katase Fujisawa-shi, Kanagawa-ken 251-8531 Japan
Measuring instrument	A single point load cell , with strain gauges, tested as a part of a weighing instrument.
	Brand : Minebea or Minebea Intec Designation : M080 or PR55
	Further properties are described in the annexes: - Description TC11207 revision 0; - Documentation folder TC11207-1.
	An overview of performed tests is given in the annex: - Description TC11207 revision 0.
Issuing Authority	NMI Certin B.V. 13 March 2018
	 C. Oosterman Head Certification Board
NMI Certin B.V. Hugo de Grootplein 1 3314 EG Dordrecht The Netherlands T +31 78 6332332 certin@nmi.nl www.nmi.nl	This document is issued under the provision that no liability is accepted and that the producer shall indemnify third-party liability.
	Reproduction of the complete document only is permitted
	



Description

Number **TC11207** revision 0
Project number 1902088
Page 1 of 2

1 General information about the load cell

All properties of the load cell, whether mentioned or not, shall not be in conflict with the standards mentioned in this certificate.

This certificate is the positive result of the applied voluntary, modular approach, for a component of a measuring instrument, as described in WELMEC 8.8. The complete measuring system must be covered by an EC type-approval certificate, an EC-type examination certificate or an EU-type examination certificate.

1.1 Essential parts

Number	Pages	Description	Remark
11207/0-01	1	M080, PR55 load cell outline	Mechanical / electrical

Cable:

- The load cell is provided with a 6-wire system (=“Remote-sensing”):
- The cable length is not limited.

The cable shall be a shielded; the shield is connected to the load cell.

1.2 Essential characteristics

Maximum capacity (E_{max})	11 kg up to 50 kg	50 kg up to and including 200 kg
Minimum dead load	0 kg	
Accuracy Class	C	
Rated Output	2,0 mV/V	
Maximum number of load cell intervals (n) ⁽¹⁾	3000	
Ratio of minimum LC Verification interval ⁽¹⁾ $Y = E_{max} / V_{min}$	24700	25000
Ratio of minimum dead load output return ⁽¹⁾ $Z = E_{max} / (2 * DR)$	7500	
Input impedance	1100 $\Omega \pm 50 \Omega$	
Temperature range	-10 °C / + 40 °C	
Fraction p_{LC}	0,7	
Humidity Class	CH	
Safe overload	150 % of E_{max}	
Output impedance	960 $\Omega \pm 50 \Omega$	
Recommended excitation	10 V AC / DC	
Excitation maximum	15 V AC / DC	



Description

Number **TC11207** revision 0
Project number 1902088
Page 2 of 2

Transducer material	Stainless steel
Atmospheric protection	Hermetically welded

Remark:

1. The characteristics for n_{max} , Y and Z can be reduced separately.

1.3 Essential shapes

Number	Pages	Description	Remark
11207/0-01	1	M080, PR55 load cell outline	Mechanical / electrical

The descriptive markings plate is secured against removal by sealing or will be destroyed when removed and contains at least the information and markings as described in OIML R 60 (2000) and:

- This certificate number TC11207 (in the countries where it is mandatory);
- Producers name or mark.

2 Seals

The connecting cable of the load cell or the junction box is provided with possibility to seal.

3 Conditions for conformity assessment

Each load cell produced is provided with an accompanying document with information about its characteristics.

The compatibility of load cells and indicator is established by the manufacturer by means of the compatibility of modules form, contained in WELMEC 2, 2015 clause 10, at the time of putting into use.

Other parties may use this certificate without the written permission of the producer (WELMEC 8.8).

4 Reports

An overview of performed tests is given in the reports:

- No. NMI-1902088-01 dated 13 March 2018 that includes 51 pages;
- No. NMI-1902088-02 dated 13 March 2018 that includes 46 pages.

A report can be a test report, an evaluation report, a type evaluation report and/or a pattern evaluation report.

8.6 BVS 21 ATEX E 023 X

DEKRA

1 **EU-Baumusterprüfbescheinigung**

2 **Geräte zur bestimmungsgemäßen Verwendung in explosionsgefährdeten Bereichen
Richtlinie 2014/34/EU**

3 Nr. der EU-Baumusterprüfbescheinigung: **BVS 21 ATEX E 023 X**

4 Produkt: **Wägezellen Typ M****-***** alternativ Typ PR **-*******

5 Hersteller: **Minebea Mitsumi Inc.**

6 Anschrift: **1-1-1 Katase Fujisawa, Kanagawa, Japan**

7 Die Bauart dieses Produktes sowie die verschiedenen zulässigen Ausführungen sind in der Anlage zu dieser Baumusterprüfbescheinigung festgelegt.

8 Die Zertifizierungsstelle der DEKRA Testing and Certification GmbH, benannte Stelle Nr. 0158 gemäß Artikel 17 der Richtlinie 2014/34/EU des Europäischen Parlaments und des Rates vom 26. Februar 2014, bescheinigt, dass das Produkt die wesentlichen Gesundheits- und Sicherheitsanforderungen für die Konzeption und den Bau von Produkten zur bestimmungsgemäßen Verwendung in explosionsgefährdeten Bereichen gemäß Anhang II der Richtlinie erfüllt. Die Ergebnisse der Prüfung sind in dem vertraulichen Prüfprotokoll BVS PP 21.2035 EU niedergelegt.

9 Die wesentlichen Gesundheits- und Sicherheitsanforderungen werden erfüllt unter Berücksichtigung von:



EN IEC 60079-0:2018	Allgemeine Anforderungen
EN IEC 60079-7:2015 + A1:2018	Erhöhte Sicherheit „e“
EN 60079-11:2012	Eigensicherheit „i“
EN 60079-31:2014	Schutz durch Gehäuse „t“

mit Ausnahme der Anforderungen, die in Abschnitt 18 der Anlage aufgeführt werden.

10 Falls das Zeichen „X“ hinter der Bescheinigungsnummer steht, wird in der Anlage zu dieser Bescheinigung auf besondere Bedingungen für die sichere Anwendung des Produktes hingewiesen.

11 Diese EU-Baumusterprüfbescheinigung bezieht sich nur auf den Entwurf und Bau der beschriebenen Produkte.
Für den Herstellungsprozess und die Abgabe der Produkte sind weitere Anforderungen der Richtlinie zu erfüllen, die nicht durch diese Bescheinigung abgedeckt sind.

12 Die Kennzeichnung des Produktes muss die folgenden Angaben enthalten:

	II 1G Ex ia IIC T6/T4 Ga	M****-***** 0 *** alternativ
	II 1D Ex ia IIIC T₂₀₀165°C Da	PR **-***** E
	II 3G Ex ec IIC T6/T4 Gc	M****-***** 2 *** alternativ
	II 2D Ex tb IIIC T110°C Db	PR **-***** **

DEKRA Testing and Certification GmbH
Bochum, 07.06.2021

Geschäftsführer



Seite 1 von 4 zu BVS 21 ATEX E 023 X – Jobnumber 341428900
Dieses Zertifikat darf nur vollständig und unverändert weiterverbreitet werden.

DEKRA Testing and Certification GmbH, Handwerkstraße 15, 70565 Stuttgart
Zertifizierungsstelle: Dinnendahlstraße 9, 44809 Bochum
Telefon +49 234 3696-400, Fax +49 234 3696-401, DTC-Certification-body@dekra.com



13 **Anlage zur**

14 **EU-Baumusterprüfbescheinigung**

BVS 21 ATEX E 023 X

15 **Beschreibung des Produktes**

15.1 **Gegenstand und Typ**

Wägezellen Typ M***-**** * * * *

Stern	Bedeutung
1+2	Typ der Wägezelle M010, M020, M030, M040, M050, M060, M070, M080, M090, M100, M110, M130
3-6	Kapazität der Wägezelle in kg (Abhängig vom jeweiligen Typ) 0005 5 kg 07.5 7,5 kg 5099 5099 kg
7	Genauigkeit (nicht Ex-relevant)
8	Ex Schutz 0 Einsatz in Zone 0 und 20 2 Einsatz in Zone 2 und 21
9+10	Länge der fest angeschlossenen Leitung in Meter (Abhängig vom jeweiligen Typ)
11	Nicht Ex-relevant

Alternativ Typ PR **-**** * * * *

Stern	Bedeutung
1+2	Typ der Wägezelle PR 40, PR 43, PR 54, PR 44, PR 57, PR 47, PR 53, PR 55, PR 58, PR 77, PR 79, PR 78
3-6	Kapazität der Wägezelle (Abhängig vom jeweiligen Typ) 0005 5 kg 07.5 7,5 kg 5099 5099 kg
7-8	Einheit der Kapazität [kg] oder [t]
9	Ex Schutz E Einsatz in Zone 0 und 20 ohne Einsatz in Zone 2 und 21

Seite 2 von 4 zu BVS 21 ATEX E 023 X – Jobnumber 341428900
Dieses Zertifikat darf nur vollständig und unverändert weiterverbreitet werden.

DEKRA Testing and Certification GmbH, Handwerkstraße 15, 70565 Stuttgart
Zertifizierungsstelle: Dimendahlstraße 9, 44809 Bochum
Telefon +49.234.3696-400, Fax +49.234.3696-401, DTC-Certification-body@dekra.com



15.2

Beschreibung

Die Wägezellen Typ M***.*** * 0 ** * alternativ Typ PR **.*** ** 0 sind für den Einsatz in Zone 0 und Zone 20 (EPL Ga und Da) in der Zündschutzart Eigensicherheit „i“ ausgeführt. Die Wägezellen Typ M***.*** * 2 ** * alternativ Typ PR **.*** ** 2 sind für den Einsatz in Zone 2 und Zone 21 (EPL Gc und Db) in den Zündschutzarten Erhöhte Sicherheit „ec“ und Schutz durch Gehäuse „tb“ ausgeführt.

Die Wägezellen bestehen aus einem massiven Metallblock, welcher mit Dehnungsmessstreifen versehen ist. Abhängig vom jeweiligen Typ werden die Dehnungsmessstreifen entweder komplett vergossen oder der Raum wird mit einem Metallstopfen gasdicht verschweißt.

Das Metallgehäuse der Typen M010, PR 40, M020, PR 43, M040, PR 44, M060 und PR 47 besteht aus Aluminium.

Das Metallgehäuse der Typen M030, PR 54, M050, PR 57, M070, PR 53, M080, PR 55, M090, PR 58, M100, PR 77, M110, PR 79, M130 und PR 78 besteht aus Chrom-Nickel-Stahl.

Der Anschluss erfolgt über die fest angeschlossenen Leitungen, die direkt in den vergossenen oder verschweißten Raum führen. Die Farbe des Leitungsmantels ist immer grün. Bei den eigensicheren Typen wird zur Kennzeichnung ein blauer Schrumpfschlauch verwendet. Die Einführung erfolgt über eine eigenproduzierte Kabel- und Leitungseinführung die auch Gegenstand dieser Baumusterprüfung ist.

Auflistung aller verwendeten Komponenten mit älterem Normenstand

Keine

15.3

Kenngößen

Nicht eigensichere Kenngößen (Typ M***.*** * 2 ** * / PR **.*** **)

Bemessungsspannung		30	VDC
Bemessungsstrom		500	mA
Bemessungsleistung		3,1	W

Eigensichere Kenngößen (Typ M***.*** * 0 ** * / PR **.*** ** E)

Maximale Eingangsspannung	U _i	30	VDC
Maximaler Eingangsstrom	I _i	500	mA
Maximale Eingangsleistung	P _i	1,8	W für T6 (Typ PR53)
		1,95	W für T6 (alle anderen Typen)
		4	W für T4 (alle Typen)

Die Wägezellen enthalten keine konzentrierten Kapazitäten oder Induktivitäten.

Maximale innere Kapazität	C _i	130	pF / m
Maximale innere Induktivität	L _i	0,95	µH / m

Thermische Kenngößen

Umgebungstemperaturbereich / Temperaturklasse / Oberflächentemperatur

-30 °C ≤ T_{amb} ≤ 40 °C (T6)-30 °C ≤ T_{amb} ≤ 70 °C (T4 und Staub)

16

Prüfprotokoll

BVS PP 21.2035 EU, Stand 07.06.2021



Seite 3 von 4 zu BVS 21 ATEX E 023 X – Jobnumber 341428900
Dieses Zertifikat darf nur vollständig und unverändert weiterverbreitet werden.

DEKRA Testing and Certification GmbH, Handwerkstraße 15, 70565 Stuttgart
Zertifizierungsstelle: Dinnendahlstraße 9, 44809 Bochum
Telefon +49.234.3696-400, Fax +49.234.3696-401, DTC-Certification-body@dekra.com

Translation

1 EU-Type Examination Certificate

2 **Equipment intended for use in potentially explosive atmospheres**
Directive 2014/34/EU

3 EU-Type Examination Certificate Number: **BVS 21 ATEX E 023 X**

4 Product: **Load cell type M***-**** * * * * * alternatively type PR **-**** * * ***

5 Manufacturer: **Minebea Mitsumi Inc.**

6 Address: **1-1-1 Katase Fujisawa, Kanagawa, Japan**

7 This product and any acceptable variations thereto are specified in the appendix to this certificate and the documents referred to therein.

8 DEKRA Testing and Certification GmbH, Notified Body number 0158, in accordance with Article 17 of Directive 2014/34/EU of the European Parliament and of the Council, dated 26 February 2014, certifies that this product has been found to comply with the Essential Health and Safety Requirements relating to the design and construction of products intended for use in potentially explosive atmospheres given in Annex II to the Directive.
The examination and test results are recorded in the confidential Report No. BVS PP 21.2035 EU.

9 The Essential Health and Safety Requirements are assured in consideration of:



EN IEC 60079-0:2018	General requirements
EN IEC 60079-7:2015 + A1:2018	Increased Safety "e"
EN 60079-11:2012	Intrinsic Safety "i"
EN 60079-31:2014	Protection by Enclosure "t"

Except in respect of those requirements listed under item 18 of the appendix.

10 If the sign "X" is placed after the certificate number, it indicates that the product is subject to the Special Conditions for Use specified in the appendix to this certificate.

11 This EU-Type Examination Certificate relates only to the design and construction of the specified product. Further requirements of the Directive apply to the manufacturing process and supply of this product. These are not covered by this certificate.

12 The marking of the product shall include the following:

	II 1G Ex ia IIC T6/T4 Ga	M***-**** * 0 * * * * alternatively
	II 1D Ex ia IIIC T₂₀₀165°C Da	PR **-**** * * E
	II 3G Ex ec IIC T6/T4 Gc	M***-**** * 2 * * * * alternatively
	II 2D Ex tb IIIC T110°C Db	PR **-**** * * *

DEKRA Testing and Certification GmbH
Bochum, 2021-06-07

Signed: Jörg-Timm Kilisch

Managing Director

Page 1 of 4 of BVS 21 ATEX E 023 X – Jobnumber 341428900
This certificate may only be reproduced in its entirety and without any change.

 DEKRA Testing and Certification GmbH, Handwerkstr. 15, 70565 Stuttgart, Germany
Certification body: Dinnendahlstr. 9, 44809 Bochum, Germany
Phone +49.234.3696-400, Fax +49.234.3696-401, e-mail DTC-Certification-body@dekra.com



13 **Appendix**

14 **EU-Type Examination Certificate**

BVS 21 ATEX E 023 X

15 **Product description**

15.1 **Subject and type**

Load cell type M***-**** * * * *

Asterisk	Description
1+2	Type of load cell M010, M020, M030, M040, M050, M060, M070, M080, M090, M100, M110, M130
3-6	Capacity of the load cell in kg (depending on the type) 0005 5 kg 07.5 7.5 kg 5099 5099 kg
7	Accuracy (not Ex-relevant)
8	Ex protection 0 Useable in Zone 0 and 20 2 Useable in Zone 2 and 21
9+10	Length of the permanently attached supply line in meter (depending on the type)
11	Not Ex-relevant

Alternatively type PR **-**** * * *

Asterisk	Description
1+2	Type of load cell PR 40, PR 43, PR 54, PR 44, PR 57, PR 47, PR 53, PR 55, PR 58, PR 77, PR 79, PR 78
3-6	Capacity of the load cell (depending on the type)
7-8	Unit of the capacity value [kg] or [t]
9	Ex protection E Useable in Zone 0 and 20 w/o Useable in Zone 2 and 21

Page 2 of 4 of BVS 21 ATEX E 023 X – Jobnumber 341428900
 This certificate may only be reproduced in its entirety and without any change.



DEKRA Testing and Certification GmbH, Handwerkstr. 15, 70565 Stuttgart, Germany
 Certification body: Dinnendahlstr. 9, 44809 Bochum, Germany
 Phone +49.234.3696-400, Fax +49.234.3696-401, e-mail DTC-Certification-body@dekra.com



17.3 The cable glands have been tested with a reduced tensile force according to section A.3.1 of EN IEC 60079-0 and may only be used with fixed installation. The user must ensure that the cable is sufficiently secured.

17.4 High or repeating charging processes must be excluded for use in EPL Ga.

17.5 The non-metallic surfaces of the load cells must be protected from mechanical hazards by the installation.

18 Essential Health and Safety Requirements

The Essential Health and Safety Requirements are covered by the standards listed under item 9. In addition to the Essential Health and Safety Requirements are covered by the standards listed under item 9, the following are considered relevant to this product, and conformity is demonstrated in the report:
 The standard IEC 60079-7:2015 Ed. 5.1 used in the annex is technically identical to the EN Standard listed on the front page.
 The standard IEC 60079-0:2017 Ed. 7 used in the annex is technically identical to the EN IEC standard listed on the front page. For this product is the standard IEC 60079-0:2017 in terms of safety equivalent to the harmonized standard EN IEC 60079-0:2018. The marking meets the requirements of Directive 2014/34/EU (see clause 5 of this Test Report).

19 Drawings and Documents

Drawings and documents are listed in the confidential report.

We confirm the correctness of the translation from the German original.
 In the case of arbitration only the German wording shall be valid and binding.

DEKRA Testing and Certification GmbH
 Bochum, 2021-06-07
 BVS-Hil/Kir A20190777



 Managing Director

Page 4 of 4 of BVS 21 ATEX E 023 X – Jobnumber 341428900
 This certificate may only be reproduced in its entirety and without any change.

 DEKRA Testing and Certification GmbH, Handwerkstr. 15, 70565 Stuttgart, Germany
 Certification body: Dinnendahlstr. 9, 44809 Bochum, Germany
 Phone +49.234.3696-400, Fax +49.234.3696-401, e-mail DTC-Certification-body@dekra.com

8.7 IECEx BVS 21.0024X

		<h2>IECEx Certificate of Conformity</h2>	
INTERNATIONAL ELECTROTECHNICAL COMMISSION IEC Certification System for Explosive Atmospheres <small>for rules and details of the IECEx Scheme visit www.iecex.com</small>			
Certificate No.:	IECEx BVS 21.0024X	Page 1 of 3	Certificate history
Status:	Current	Issue No: 0	
Date of Issue:	2021-06-10		
Applicant:	MinebeaMitsumi Inc. 1-1-1 Katase Fujisawa-shi Kanagawa, 251-8531 Japan		
Equipment:	Load cell type M***-**** * ** * alternatively type PR **-**** **		
Optional accessory:			
Type of Protection:	Intrinsic Safety "i"; Protection by enclosure "t"; Increased Safety "e"		
Marking:	M***-**** * 0 ** * alternatively PR **-**** ** Ex ia IIC T6/T4 Ga Ex ia IIIC T₂₀₀165°C Da M***-**** * 2 ** * alternatively PR **-**** ** Ex ec IIC T6/T4 Gc Ex tb IIIC T110°C Db		
Approved for issue on behalf of the IECEx Certification Body:	Jörg Koch		
Position:	Head of Certification Body		
Signature: (for printed version)	_____		
Date:	_____		
1. This certificate and schedule may only be reproduced in full. 2. This certificate is not transferable and remains the property of the issuing body. 3. The Status and authenticity of this certificate may be verified by visiting www.iecex.com or use of this QR Code.			
Certificate issued by: DEKRA Testing and Certification GmbH Certification Body Dinnendahlstrasse 9 44809 Bochum Germany		  DEKRA On the safe side.	

		<h2>IECEX Certificate of Conformity</h2>	
Certificate No.:	IECEX BVS 21.0024X	Page 2 of 3	
Date of issue:	2021-06-10	Issue No: 0	
Manufacturer:	MinebeaMitsumi Inc. 1-1-1 Katase Fujisawa-shi Kanagawa, 251-8531 Japan		
Additional manufacturing locations:	NMB-Minebea Thai Ltd. 5/2 Moo 8 Phaholyothin Road Km.149 T. Nikom Sang Ton-Eng A.Muang Lopburi Province 15000 Thailand	Minebea Electronics & Hi-tech Components (Shanghai) Ltd. No.5202 Lian Xi Rd. Jinze Town Qingpu District Shanghai 201721 China	
<p>This certificate is issued as verification that a sample(s), representative of production, was assessed and tested and found to comply with the IEC Standard list below and that the manufacturer's quality system, relating to the Ex products covered by this certificate, was assessed and found to comply with the IECEX Quality system requirements. This certificate is granted subject to the conditions as set out in IECEX Scheme Rules, IECEX 02 and Operational Documents as amended</p>			
<p>STANDARDS : The equipment and any acceptable variations to it specified in the schedule of this certificate and the identified documents, was found to comply with the following standards</p>			
IEC 60079-0:2017	Explosive atmospheres - Part 0: Equipment - General requirements		
Edition:7.0			
IEC 60079-11:2011	Explosive atmospheres - Part 11: Equipment protection by intrinsic safety "I"		
Edition:6.0			
IEC 60079-31:2013	Explosive atmospheres - Part 31: Equipment dust ignition protection by enclosure "t"		
Edition:2			
IEC 60079-7:2017	Explosive atmospheres - Part 7: Equipment protection by increased safety "e"		
Edition:5.1			
<p>This Certificate does not indicate compliance with safety and performance requirements other than those expressly included in the Standards listed above.</p>			
<p>TEST & ASSESSMENT REPORTS: A sample(s) of the equipment listed has successfully met the examination and test requirements as recorded in:</p>			
<p>Test Report:</p> <p>DE/BVS/ExTR21.0028/00</p>			
<p>Quality Assessment Reports:</p> <p>NL/DEK/QAR17.0006/02 NL/DEK/QAR17.0007/02 NL/DEK/QAR17.0008/02</p>			



IECEX Certificate of Conformity

Certificate No.: **IECEX BVS 21.0024X**

Page 3 of 3

Date of issue: 2021-06-10

Issue No: 0

EQUIPMENT:

Equipment and systems covered by this Certificate are as follows:

Subject and Type

See Annex

Listing of all components used referring to older standards

None

Description

The load cells type M***-**** * 0 *** alternatively type PR **-**** ** E are designed for use in zone 0 and zone 20 (EPL Ga and Da) in the type of protection intrinsic safety "i". The load cells type M***-**** * 2 *** alternatively type PR **-**** ** are designed for use in zone 2 and zone 21 (EPL Gc and Db) in the type of protection increased safety "ec" and protection by enclosure "tb".

The load cells consist of a solid metal block, which is provided with strain gauges. Depending on the type, the strain gauges are either completely encapsulated or the space is welded gas-tight with a metal plug.

The metal housing of types M010, PR 40, M020, PR 43, M040, PR 44, M060 and PR 47 is made of aluminium.

The metal housing of types M030, PR 54, M050, PR 57, M070, PR 53, M080, PR 55, M090, PR 58, M100, PR 77, M110, PR 79, M130 and PR 78 is made of chrome-nickel steel.

Parameters

See Annex

SPECIFIC CONDITIONS OF USE: YES as shown below:

1 Special conditions for use to be listed in EU Type Examination Certificate

1.1 The equipment is suitable for an ambient temperature range from -30 °C up to 40 °C for temperature class T6 and an ambient temperature range from -30 °C up to 70 °C for temperature class T4 or dust applications.

1.2 The equipment has to be installed in such a way that any ignition hazards caused by impact or friction can be excluded for use in EPL Ga.

1.3 The cable glands have been tested with a reduced tensile force according to section A.3.1 of IEC 60079-0 and may only be used with fixed installation. The user must ensure that the cable is sufficiently secured.

1.4 High or repeating charging processes must be excluded for use in EPL Ga.

1.5 The non-metallic surfaces of the load cells must be protected from mechanical hazards by the installation.

2 Additional special conditions for use

2.1 When used in gas group IIC, the permanently connected wire must be additionally protected against manual charging. Note included in the safety instructions, warning information on electrostatic discharge included on the type plate.

Annex:

[BVS_21_0024X_Minebea_Annex.pdf](#)



IECEX Certificate of Conformity



Certificate No.: IECEx BVS 21.0024X
Annex
Page 1 of 1

Subject and Type

Load cell type M***.*** ** ** *

Asterisk	Description
1+2	Type of load cell M010, M020, M030, M040, M050, M060, M070, M080, M090, M100, M110, M130
3-6	Capacity of the load cell in kg (depending on the type) 0005 5 kg 07.5 7.5 kg 5099 5099 kg
7	Accuracy (not Ex-relevant)
8	Ex protection 0 Useable in Zone 0 and 20 2 Useable in Zone 2 and 21
9+10	Length of the permanently attached supply line in meter (depending on the type)
11	Not Ex-relevant

Alternatively type PR **.*** ** *

Asterisk	Description
1+2	Type of load cell PR 40, PR 43, PR 54, PR 44, PR 57, PR 47, PR 53, PR 55, PR 58, PR 77, PR 79, PR 78
3-6	Capacity of the load cell (depending on the type)
7-8	Unit of the capacity value [kg] or [t]
9	Ex protection E Useable in Zone 0 and 20 w/o Useable in Zone 2 and 21

Parameters

Non-intrinsically safe parameters (type M***.*** ** ** * / PR **.*** ** *)

Rated voltage		30	VDC
Rated current		500	mA
Rated power		3.1	W

Intrinsically safe parameters (type M***.*** ** ** * / PR **.*** ** * E)

Maximum input voltage	U_i	30	VDC
Maximum input current	I_i	500	mA
Maximum input power	P_i	1.8	W for T6 (type PR53)
		1.95	W for T6 (all other types)
		4	W for T4 (all types)
The load cells do not contain any concentrated capacitances or inductances.			
Maximum internal capacitance	C_i	130	pF / m
Maximum internal inductance	L_i	0.95	μH / m



IECEX Certificate of Conformity



Certificate No.: **IECEX BVS 21.0024X**
Annex
Page 2 of 1

Thermal parameters

Ambient temperature range / Temperature class / Surface temperature $-30\text{ }^{\circ}\text{C} \leq T_{\text{amb}} \leq 40\text{ }^{\circ}\text{C}$ (T6)
 $-30\text{ }^{\circ}\text{C} \leq T_{\text{amb}} \leq 70\text{ }^{\circ}\text{C}$ (T4 and dust)

Published by
Minebea Intec GmbH | Meiendorfer Strasse 205 A | 22145 Hamburg, Germany
Phone: +49.40.67960.303 | Email: info@minebea-intec.com
www.minebea-intec.com

