

Installation Manual

Single Point Load Cell PR 57



Foreword

Must be followed!

Any information in this document is subject to change without notice and does not represent a commitment on the part of Minebea Intec unless legally prescribed. This product should only be operated/installed by trained and qualified personnel. In correspondence concerning this product, the type, name, and release number/serial number as well as all license numbers relating to the product have to be cited.

Note

This document is partially protected by copyright. It may not be changed or copied, and it may not be used without purchasing or written permission from the copyright owner (Minebea Intec). The use of this product constitutes acceptance by you of the abovementioned provisions.

Table of contents

1	Introduction	3
1.1	Read the manual.....	3
1.2	This is what operating instructions look like.....	3
1.3	This is what lists look like.....	3
1.4	This is what menu items and softkeys look like.....	3
1.5	This is what the safety instructions look like.....	3
1.6	Hotline.....	4
2	Safety instructions	5
2.1	General notes.....	5
2.2	Intended use.....	5
2.3	Initial inspection.....	5
2.4	Before operational startup.....	5
3	Specifications	6
3.1	Equipment supplied with the load cell.....	6
3.2	General information.....	6
3.3	Possible marking of the load cell for the Ex area.....	7
3.4	Dimensions.....	8
3.5	Ordering information.....	8
3.6	Technical data.....	9
4	Installation	11
4.1	Safety instructions.....	11
5	Connection	12
5.1	General information.....	12
5.2	Load cell.....	13
5.3	Load cell cable.....	13
5.4	Cable gland.....	14
6	Maintenance/repairs/cleaning	15
6.1	Maintenance.....	15
6.2	Repairs.....	15
6.3	Cleaning.....	15
7	Disposal	16
8	Certificates	17
8.1	CE-00049A.....	18
8.2	UKCA-00008.....	24
8.3	17-012.....	25
8.4	10051.....	27

8.5	R60/2000-NL1-17.29	28
8.6	TC10952.....	30
8.7	BVS 21 ATEX E 023X	33
8.8	IECEX BVS 21.0024X.....	41

1 Introduction

1.1 Read the manual

- Please read this manual carefully and completely before using the product.
- This manual is part of the product. Keep it in a safe and easily accessible location.

1.2 This is what operating instructions look like

1. - n. are placed before steps that must be done in sequence.
 - ▶ is placed before a step.
 - ▷ describes the result of a step.

1.3 This is what lists look like

- indicates an item in a list.

1.4 This is what menu items and softkeys look like

[] frame menu items and softkeys.

Example:

[Start]- [Applications]- [Excel]

1.5 This is what the safety instructions look like

Signal words indicate the severity of the danger involved when measures for preventing hazards are not followed.

DANGER

Warning of personal injury

DANGER indicates death or severe, irreversible personal injury which will occur if the corresponding safety measures are not observed.

- ▶ Take the corresponding safety precautions.

WARNING

Warning of hazardous area and/or personal injury

WARNING indicates that death or severe, irreversible injury may occur if appropriate safety measures are not observed.

- ▶ Take the corresponding safety precautions.

CAUTION

Warning of personal injury.

CAUTION indicates that minor, reversible injury may occur if appropriate safety measures are not observed.

- ▶ Take the corresponding safety precautions.

NOTICE**Warning of damage to property and/or the environment.**

NOTICE indicates that damage to property and/or the environment may occur if appropriate safety measures are not observed.

- ▶ Take the corresponding safety precautions.
-

Note:

User tips, useful information, and notes.

1.6 Hotline

Phone: +49.40.67960.444

Fax: +49.40.67960.474

eMail: help@minebea-intec.com

2 Safety instructions

2.1 General notes

NOTICE

Warning of damage to property and/or the environment.

The product was in perfect condition with regard to safety features when it left the factory.

- ▶ To maintain this condition and to ensure safe operation, the user must follow the instructions and observe the warnings in this manual.

2.2 Intended use

The load cells are designed for use in table scales, counting scales, and checkweighers.

The load cells PR 57 may only be used as intended for weighing tasks.

In intrinsically safe circuits, only load cells PR 57/..E may be used.

The dimensions of all mounting and structural components must be calculated so that sufficient overload capacity is ensured for all loads which may occur while taking the relevant standards into account. In particular, upright weighing objects must be safeguarded against the weighing installation turning over or being shifted, thus eliminating danger to people, animals, or goods even in the case of a break in a load cell or mounting element.

Installation and repair work must only be carried out by expert/qualified personnel.

The load cells reflect the state of the art. The manufacturer does not accept any liability for damage caused by third-party system components or due to incorrect use of the product.

2.3 Initial inspection

Check the contents of the consignment for completeness. Check the contents visually to determine whether any damage has occurred during transport. If there are grounds for rejection of the goods, a claim must be filed with the carrier immediately. The Minebea Intec sales or service organization must also be notified.

2.4 Before operational startup

NOTICE

Perform visual inspection.

- ▶ Before operational startup as well as after storage or transport, inspect the load cell visually for signs of mechanical damage.
- ▶ The load cell should not be commissioned if it displays signs of visible damage and/or is defective.

3 Specifications

3.1 Equipment supplied with the load cell

No.	Description
1	Load cell
2	Quick guide
3	Calibration Certificate
4	Only with Ex-load cells: Safety information for PR xx series

3.2 General information

Material	Stainless steel
Protection against environmental influences	Silicone potting
Protection classes	in compliance with IEC 529 or DIN EN 60529 IP 66/IP67: Dust-proof and leak-tight against strong jet water, with harmful effects when immersed, (1 m water depth, 30 minutes). Explosion: Suitable for explosion subgroup IIC and IIIC.
EMC	High frequency electromagnetic fields acc. to EN 61000-4-3 10 V/m
Cable diameter	5 mm
Cable length	see data sheet
Cable gauge	6×0.14 mm ²
Cable bend radius	≥25 mm (fixed installation) ≥75 mm (flexible installation)
Cable sheath material	Thermoplastic elastomer (TPE)
Cable sheath color	Green, Ex version with blue marking
max. platform size in compliance with the technical data according to OIML R76	600 mm × 600 mm

3.3 Possible marking of the load cell for the Ex area

Zone	Marking	Certificate no.	for
0	II 1G Ex ia IIC T6/T4 Ga Ex ia IIC T6/T4 Ga	BVS 21 ATEX E 023 X IECEX BVS 21.0024 X	only PR 5x/..E
20	II 1D Ex ia IIIC T ₂₀₀ 165°C Da Ex ia IIIC T ₂₀₀ 165°C Da	BVS 21 ATEX E 023 X IECEX BVS 21.0024 X	only PR 5x/..E
2	II 3G Ex ec IIC T6/T4 Gc Ex ec IIC T6/T4 Gc	BVS 21 ATEX E 023 X IECEX BVS 21.0024 X	all PR 5x without /..E
21	II 2D Ex tb IIIC T110°C Db Ex tb IIIC T110°C Db	BVS 21 ATEX E 023 X IECEX BVS 21.0024 X	all PR 5x without /..E

NOTICE

Installation in the Ex area

- ▶ For installations in the Ex area, it is imperative to observe the Ex safety instructions in the installation manuals.

⚠ WARNING

Warning of hazardous area and/or personal injury

When used in a dust ex zone, the risk of electrostatic charging must be minimized.

- ▶ Dust layers on the load cell >5 mm are not permitted.
- ▶ The load cell must be installed securely.

3.4 Dimensions

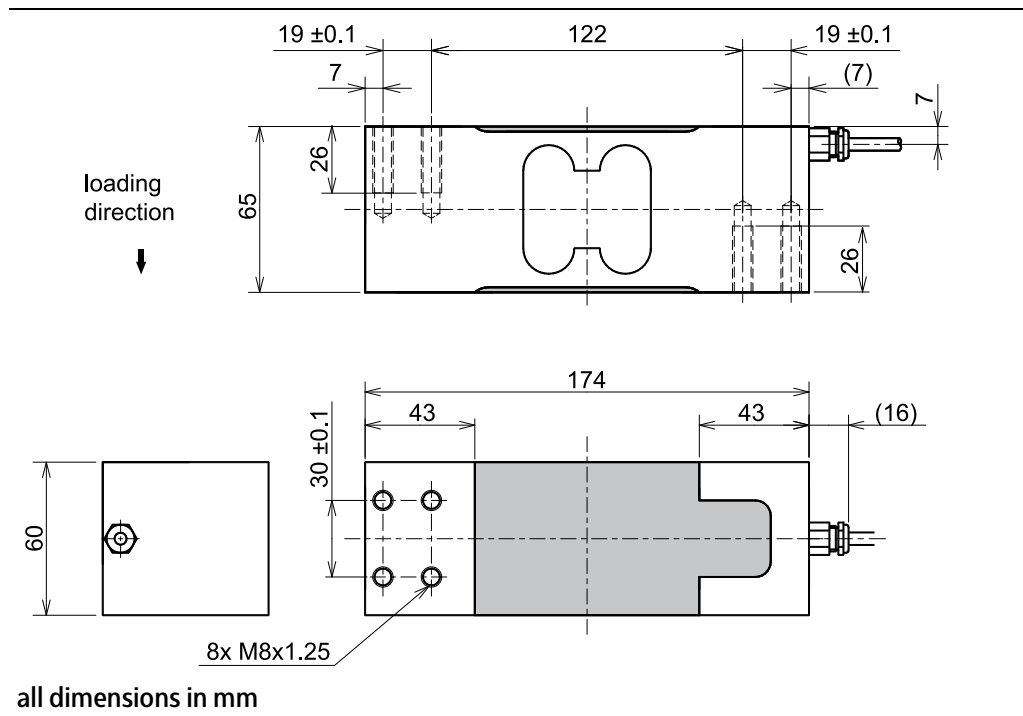

3.5 Ordering information

Model	Max. capacity E_{max}	Type OIML	Type Ex	Type NTEP
PR 57/300 kg	300 kg	..C3MR	..C3MRE	..III5000S
PR 57/500 kg	500 kg	..C3MR	..C3MRE	..III5000S

3.6 Technical data

Designation	Description	Abbr.	C3MR	NTEP III 5000 Single	Unit
Accuracy class			0.02	0.014	% E_{max}
Minimum dead load	lowest limit of specified measuring range	E_{min}	0	0	% E_{max}
Maximum capacity	highest limit of specified measuring range	E_{max}	see Chapter 3.5		
Safe load limit	maximum load without irreversible damage	E_{lim}		150	% E_{max}
Destructive load	danger of mechanical destruction	E_d		300	% E_{max}
Minimum LC verification	minimum load cell scale interval, $v_{min} = E_{max}/Y$	Y		15000	
Minimum preload signal recurrence	recurrence of the minimum preload signal ($DR = \frac{1}{2} \times E_{max}/Z$)	Z	3000	5000	
Rated output	relative output at maximum capacity	C_n		2	mV/V
Tolerance on rated output	permissible deviation from rated output C_n	d_c		<10	% C_n
Zero output signal	load cell output signal under unloaded condition	S_{min}		0 ± 5	% C_n
Repeatability	max. change in load cell output for repeated loading	ϵ_R	<0.0100	<0.0070	% C_n
Creep	max. change of output signal at E_{max} during 30 minutes	d_{cr}	<0.0166	<0.0100	% C_n
Non-linearity ¹⁾	deviation from best straight line through zero	d_{Lin}	<0.0166	<0.0140	% C_n
Hysteresis ¹⁾	max. difference in LC output between loading and unloading	d_{hy}	<0.0166	<0.0140	% C_n
Temperature effect on S_{min}	max. change of S_{min} in B τ	TK S_{min}		<0.0093	% $C_n/10$ K
Temperature effect on C^1	max. change of C in B τ	TK C	<0.0117	<0.0070	% $C_n/10$ K
Input impedance	between supply terminals	R_{LC}		380 ± 38	Ω
Output impedance	between measuring terminals	R_o		350 ± 25	Ω
Insulation impedance	between measuring circuit and housing at $U_{DC} = 100$ V	R_{IS}		>5000	M Ω
Insulation voltage	between circuit and housing			500	V
Recommended supply voltage	to hold the specified performance	B_u		≤ 12	V $_{DC}$

Designation	Description	Abbr.	C3MR	NTEP III 5000 Single	Unit
Max. supply voltage	permissible for continuous operation without damage	U_{\max}		15	V _{DC}
Nominal ambient temp. range	to hold the specified performance	B_T		-10...+40	°C
Usable ambient temp. range	permissible for continuous operation without damage	B_{Tu}		-20...+65	°C
Storage temperature range	without electrical and mechanical stress	B_{Ti}		-25...+70	°C
Barometric pressure influence	Umgebungsdruckeinfluss auf das Ausgangssignal			<0.007	% C _n /kPa
Nominal deflection	elastic deformation under maximum capacity	s_{nom}		<0.7	mm

- 1) The data for non-linearity (d_{Lin}), hysteresis (d_{hy}) and and temperature effect on C (TKC) are typical values.
For OIML R60 or NTEP approved load cells the sum of these values is within the permissible cumulative error limits.

Definitions acc. to OIML R60

The technical data given are intended solely as a product description and should not be interpreted as guaranteed properties in the legal sense.

Accuracy classes and min. scale interval of the load cells v_{min}

PR 57	Type	Divisions n_{max}	300 kg	500 kg	Unit
OIML	C3MR	3000	20.00	33.34	g
NTEP	Class III Single	5000	20.00	33.34	g

4 Installation

4.1 Safety instructions

NOTICE

Welding or lightning strike current flowing through the cell can damage it.

All electrical welding on the weighing system must be finished before mounting the load cells.

During any additional electrical welding work near the load cell:

- Disconnect the load cell cables.
- Bypass the load cell.
- Make sure that the grounding clamp of the welding set is fitted as closely as possible to the welding joint.

The following must be observed during installation:

- Do not lift or transport the load cell by pulling on the cable.
- Avoid shock stress (falling down, hard shocks).
- Load forces must act in the direction indicated (arrow on the load cell).

NOTICE

Changes of temperature >15 K/h may influence the measuring accuracy.

- ▶ Make sure to protect the load cells from direct heating or cooling effects (sun, wind, heat radiation, fan heaters), e.g., heat protection screens or heat protection housings are to be installed if necessary.

NOTICE

Force shunts may cause measuring errors.

- ▶ All incoming and outgoing lines (hoses, pipes, cables) must be coupled to the measured object as flexibly as possible.

5 Connection

5.1 General information

- Protect the cable ends against contamination. Moisture must not get into the open end of the cable.
- Keep the load cell cables away from power cables.
- The distance between measurement cables and power cables and/or components under high voltage should be at least 1 m (reference value).
- We recommend laying the load cell cables in separate cable trays or armored steel pipes.
- Power cables should be crossed at right angles while taking into account the minimum distance of 1 m (reference value).

Note:

If hum interference occurs, the cable screens should only be connected on one side.

Depending on the design of the cable junction box used, either the jumper J3 must be removed or the cable screens must be disconnected from the terminal contacts highlighted in yellow.

⚠ WARNING**When installing in potentially explosive atmospheres:**

It is imperative that you follow the application-dependent installation instructions!

- ▶ Always check whether it is permissible to bilaterally connect the screens to the equipotential bonding.
-

5.4 Cable gland

The cable gland is screwed to the load cell.

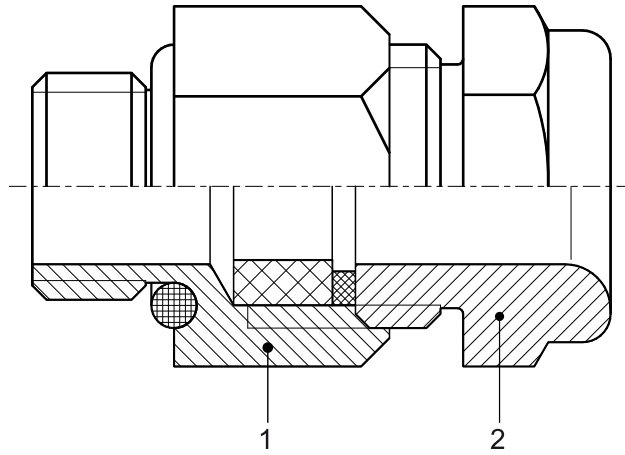

1. Screw the metal sleeve (1) into the load cell and fasten with a tightening torque of 3 Nm.
2. Screw the nut (2) into the metal sleeve and fasten with a tightening torque of 3 Nm.

6 Maintenance/repairs/cleaning

6.1 Maintenance

The load cells PR 57 are maintenance-free.

6.2 Repairs

The load cells PR 57 are designed to be robust as possible for the required measuring accuracy and are highly reliable.

Should an electrical or mechanical defect nevertheless occur, the load cell must be replaced.

Load cell repair is not possible.

6.3 Cleaning

Dirt on the load cell and movable parts of the scale must be cleaned as quickly as possible

- if it influences weighing, or
- if it is corrosive to the cell or cable material.

NOTICE

Some cleaning agents may not be compatible with the load cell material.

- ▶ When using cleaning agents, ensure that their compatibility with the load cell material has been tested and approved (see Chapter [3.2](#)).

Clean the load cell with a damp cloth to avoid electrostatic charging.

7 Disposal

Our products and their packaging should not be disposed of in municipal waste (e.g. garbage can for recyclable packaging, garbage can for paper packaging, etc.). They can either be recycled by the customer themselves, providing this complies with requirements set out by electrical or electronic waste or packaging waste laws, or sent back to Minebea Intec at a charge.

This option of returning the product is intended to provide proper recycling or reuse in a manner that is collected separately from municipal waste.

Before disposing of or scrapping the old products, any single-use or rechargeable batteries should be removed and taken to a suitable collection point. The type of battery used is specified in the technical data.

Please see our General Terms and Conditions for further information.

Service addresses for repair acceptance and collection points can be found on the product information enclosed with the product as well as on our website (www.minebea-intec.com).

Should you have any further questions, please contact your local service representative or our service center.

Minebea Intec GmbH

Repair center

Meiendorfer Strasse 205 A

22145 Hamburg, Germany

Phone: +49.40.67960.333

service.HH@minebea-intec.com

We reserve the right not to accept products that are contaminated with hazardous substances (ABC contamination).

8 Certificates

Ser. no.	Description	Document no.	see Chapter
1	EU-Declaration of Conformity	CE-00049A	8.1
2	Certificate of Conformance (NTEP)	17-012	8.3
3	Certificate of Approval (NTEP-New York)	10051	8.4
4	OIML Certificate of Conformity (NMI)	R60/2000-NL1-17.29	8.5
5	Parts Certificate/Test Certificate (NMI)	TC10952	8.6
6	EC-Type Examination Certificate	BVS 21 ATEX E 023X	8.7
7	Certificate of Conformity	IECEX BVS 21.0024X	8.8

8.1 CE-00049A



CE-00049A

EU-Declaration of Conformity



Passion to Create Value through Difference

1. Product model / product number:

	Single Point Type Load Cell / PR 57, M050
--	---

2. Name and address of the manufacturer (2.1) and his authorized representative (2.2):

2.1	MinebeaMitsumi Inc. Sensing Device Business Unit, 1-1-1 Katase, Fujisawa-shi, Kanagawa, Japan
2.2	/

3. This declaration of conformity is issued under the sole responsibility of the manufacturer.

4. Object(s) of the declaration:

4.1	PR 57-*****	M050-*****N***
4.2	PR 57-***** (A.1)	M050-*****2***
4.3	PR 57-*****E	M050-*****0***

5. The object(s) of the declaration described above is in conformity with the relevant Union harmonization legislation:

		(4.1)	(4.2)	(4.3)
5.1	2014/30/EU	(6.1)	(6.1)	(6.1)
5.2	2011/65/EU	(6.2)	(6.2)	(6.2)
5.3	2014/34/EU		(6.3)	(6.4)

6. References to the relevant harmonized standards used or references to the other technical specifications in relation to which conformity is declared:

6.1	2014/30/EU	EN 61326-1:2013
6.2	2011/65/EU	EN IEC 63000:2018
6.3	2014/34/EU	EN IEC 60079-0:2018, EN IEC 60079-7:2015+A1:2018, EN 60079-31:2014
6.4	2014/34/EU	EN IEC 60079-0:2018, EN 60079-11:2012

7. The notified body w performed x and issued the certificate y relevant for z:

	w	x	y	z
7.1	0158	EU-Type Examination Certificate	BVS 21 ATEX E 023 X	(4.2)(4.3)
7.2	0344	Production Quality Assessment Notification	DEKRA 17ATEXQ0031	(4.2)(4.3)

MinebeaMitsumi Inc.
Fujisawa, 15. November. 2021



Satoshi Sato
Division Head



Satoshi Uchibori
CE Certification

1/6



EU-Declaration of Conformity

MinebeaMitsumi
Passion to Create Value through Difference

A. Additional information on ():

A.1 (4.2) Marking



II 3G Ex ec IIC T6/T4 Gc
II 2D Ex tb IIIC T110°C Db
BVS 21 ATEX E 023 X

A.2 (4.3) Marking



II 1G Ex ia IIC T6/T4 Ga
II 1D Ex ia IIIC T200 165°C Da
BVS 21 ATEX E 023 X



EU-Declaration of Conformity



български (bg)

Декларация за съответствие
 1. Модел на продукта / Номер на продукта / илустрация само за номера на проекта:
 2. Именното и адрес на производителя (2.1) и на неговия упълномощен представител (2.2):
 3. Настоящата декларация за съответствие е издадена на отговорността на производителя.
 4. Предмет(и) на декларацията:
 5. Предметът (ите) на декларацията, описан(и) по-горе отговаря(т) на съответното законодателство на Съюза за хармонизиране:
 6. Позоваване на използваните хармонизирани стандарти или позоваване на други технически спецификации, по отношение на които се декларира съответствие:
 7. Нотифицираният орган в извършил и издал сертификата Y, отнасящ се за:
 A. Допълнителна информация за ():
 A.1 Маркировка
 A.2 Маркировка

čeština (cs)

Prohlášení o shodě
 1. Model výrobku / číslo výrobku / platné pouze pro číslo projektu:
 2. Jméno a adresa výrobce (2.1) a jeho zplnomocněného zástupce (2.2):
 3. Toto prohlášení o shodě se vydává na výhradní odpovědnost výrobce.
 4. Předmět(y) prohlášení:
 5. Výše popsaný předmět / Výše popsané předměty prohlášení je/ jsou ve shodě s příslušnými harmonizačními právními předpisy Unie:
 6. Odkazy na příslušné harmonizované normy, které byly použity, nebo na jiné technické specifikace, na jejichž základě se shoda prohlašuje:
 7. Oznámený subjekt v provedl x a vydal certifikát y relevantní z hlediska z:
 A. Další informace o ():
 A.1 Označení
 A.2 Označení

dansk (da)

Overensstemmelseserklæring
 1. Produktmodel / produktnummer / gælder kun for projektnummer:
 2. Fabrikantens (2.1) og dennes bemyndigede repræsentants (2.2) navn og adresse:
 3. Denne overensstemmelseserklæring udstedes på fabrikantens ansvar.
 4. Genstand(ene) for erklæringen:
 5. Genstand(ene) for erklæringen, som beskrevet ovenfor, er i overensstemmelse med den relevante EU-harmoniseringslovgivning:
 6. Referencer til de relevante anvendte harmoniserede standarder eller til de andre tekniske specifikationer, som der erklæres overensstemmelse med:
 7. Det bemyndigede organ har foretaget x og udstedt attesten y, der gælder for z:
 A. Supplerende oplysninger om ():
 A.1 Markering
 A.2 Markering

Deutsch (de)

Konformitätserklärung
 1. Produktmodell / Produktnummer / gilt ausschließlich für Projekt-Nr.:
 2. Name und Anschrift des Herstellers (2.1) und seines Bevollmächtigten (2.2):
 3. Die alleinige Verantwortung für die Ausstellung dieser Konformitätserklärung trägt der Hersteller.
 4. Gegenstände der Erklärung:
 5. Die oben beschriebenen Gegenstände der Erklärung erfüllen die einschlägigen Harmonisierungsrechtsvorschriften der Union:
 6. Angabe der einschlägigen harmonisierten Normen oder der anderen technischen Spezifikationen, die der Konformitätserklärung zugrunde gelegt wurden:
 7. Die notifizierte Stelle w hat x und die für z relevante Bescheinigung y ausgestellt:
 A. Zusatzangaben zu ():
 A.1 Kennzeichnung
 A.2 Kennzeichnung

Ελληνικά (el)

Δήλωση συμμόρφωσης
 1. Μοντέλο προϊόντος / αριθμός προϊόντος / ισχύει μόνο για τον αριθμό του έργου:
 2. Όνομα και διεύθυνση του κατασκευαστή (2.1) και του εξουσιοδοτημένου εκπροσώπου του (2.2):
 3. Η παρούσα δήλωση συμμόρφωσης εκδίδεται με αποκλειστική ευθύνη του κατασκευαστή.
 4. Στόχος της δήλωσης:
 5. Ο στόχος της δήλωσης που περιγράφεται παραπάνω είναι σύμφωνος με τη σχετική ενοποιηκή νομοθεσία ενωμένης.
 6. Παραπομπές στα σχετικά εναρμονισμένα πρότυπα που χρησιμοποιήθηκαν ή παραπομπές στις λοιπές τεχνικές προδιαγραφές σε σχέση με τις οποίες δηλώνεται η συμμόρφωση:
 7. Ο κοινοποιημένος οργανισμός w διεξήγαγε x και εξέδωσε το πιστοποιητικό y όπως απαιτείται για z:
 A. Πρόσθετες πληροφορίες σχετικά με ():
 A.1 Σήμανση
 A.2 Σήμανση

español (es)

Declaración de conformidad
 1. Modelo de producto/número de producto / únicamente válido para el número de proyecto:
 2. Nombre y dirección del fabricante (2.1) y de su representante autorizado (2.2):
 3. La presente declaración de conformidad se expide bajo la exclusiva responsabilidad del fabricante.
 4. Objeto(s) de la declaración:
 5. El/Los objeto(s) de la declaración descritos anteriormente son conformes con la legislación de armonización pertinente de la Unión Europea:
 6. Referencias a las normas armonizadas pertinentes utilizadas o referencias a las otras especificaciones técnicas respecto a las cuales se declara la conformidad:
 7. El organismo notificado W ha efectuado X y expedido el certificado Y relevante para Z:
 A. Información adicional en ():
 A.1 Marcado
 A.2 Marcado



EU-Declaration of Conformity

MinebeaMitsumi
Passion to Create Value through Difference

cești keel (et)

Vastavusdeklaratsioon
1. Tootemudel / tootenumber / kehlib vaid järgmise projekti puhul:
2. Tootja nimi ja aadress (2.1) ning tema volitatud esindaja (2.2);
3. Käesolev vastavusdeklaratsioon on välja antud tootja ainuvastusel.
4. Deklareeritava toode:
5. Üllalrijeldatud deklareeritava toode on kooskõlas asjaomaste liidu ühtlustamisaktidega;
6. Viited kasutatud harmoneeritud standarditele või viited muudele tehnilistele spetsifikatsioonidele, millele vastavust deklareeritakse:
7. Teavitatud asutus w teostas x ja andis välja teendi z, mis on asjakohane y-le:
A. Lisateave järgmise kohta ():
A.1 Märgistus
A.2 Märgistus

français (fr)

Déclaration de conformité
1. Modèle / numéro de produit / valable uniquement pour le numéro de projet:
2. Nom et adresse du fabricant (2.1) et de son mandataire (2.2);
3. La présente déclaration de conformité est établie sous la seule responsabilité du fabricant.
4. Objet(s) de la déclaration:
5. Le ou les objets de la déclaration débite(s) cités sont conformes(s) à la législation d'harmonisation de l'Union applicable;
6. Références des normes harmonisées pertinentes appliquées ou des autres spécifications techniques par rapport auxquelles la conformité est déclarée;
7. L'organisme notifié w a effectué x et a établi l'attestation y applicable à z:
A. Informations complémentaires relatives à ():
A.1 Marquage
A.2 Marquage

hrvatski (hr)

Izjava o sukladnosti
1. Model proizvoda / broj proizvoda / vrijedi samo za broj projekta:
2. Naziv i adresa proizvođača (2.1) i njegovog ovlaštenog zastupnika (2.2);
3. Za izdavanje ove izjave o sukladnosti odgovoran je isključivo proizvođač.
4. Predmet(i) izjave:
5. Predmet(i) navedene izjave je/su u skladu s njerodavnim zakonodavstvom Unije o usklađivanju;
6. Pozivanja na relevantne priložene usklađene norme ili pozivanja na ostale tehničke specifikacije u vezi s kojima se izjavljuje sukladnost;
7. Prijavljeno tijelo w provelo je x i izdalo certifikat y koji je relevantan za z:
A. Dodatne informacije o proizvodu ();
A.1 Označavanje
A.2 Označavanje

magyar (hu)

Megfelelőségi nyilatkozat
1. Termékmódel / termékszám / kizárólag az alábbi projektszámhoz érvényes:
2. A gyártó (2.1) vagy adott esetben meghatalmazott képviselőjének (2.2) neve és címe:
3. Ezt a megfelelőségi nyilatkozatot a gyártó kizárólagos felelőssége mellett adják ki.
4. A nyilatkozat tárgya(i):
5. A fent ismertetett nyilatkozat tárgya megfelel a vonatkozó uniós harmonizációs jogszabályoknak;
6. Az alkalmazott harmonizált szabványokra való hivatkozás vagy az azokra az egyéb műszaki leírólara való hivatkozás, amelyekkel kapcsolatban megfelelőségi nyilatkozatot tettek;
7. A(z) w bejelentett szervezet elvégezte a(z) x eljárást, és kiállította a(z) z kapcsolódó y tanúsítványt:
A. További információk ():
A.1 Jelölés
A.2 Jelölés

italiano (it)

Dichiarazione di conformità
1. Modello di prodotto / numero di prodotto / valido unicamente per numero di progetto:
2. Nome e indirizzo del fabbricante (2.1) e del relativo rappresentante autorizzato (2.2);
3. La presente dichiarazione di conformità è rilasciata sotto la responsabilità esclusiva del fabbricante.
4. Oggetto/i della dichiarazione:
5. L'oggetto o gli oggetti della dichiarazione di cui sopra sono conformi alla pertinente normativa di armonizzazione dell'Unione;
6. Riferimento alle pertinenti norme armonizzate utilizzate o riferimenti alle altre specifiche tecniche in relazione alle quali è dichiarata la conformità;
7. L'organismo notificato w ha effettuato x e rilasciato il certificato y pertinente a z:
A. Informazioni aggiuntive su ():
A.1 Marcatura
A.2 Marcatura

Latvian kalba (lv)

Atbilstības deklarācija
1. Gaminio modelis / gaminio numeris / galioja tikai projekta numuriem:
2. Gaminio (2.1) ir jo igalototo atstovo (2.2) pavadnimas ir adresas:
3. Ši atbilstības deklarācija izdoita tikai gaminio atsakomybe.
4. Deklarācijas objekts (objekti):
5. Pirmaia aprašytais deklarācijas objekts (objekti) atbinka susijusius derinamosius Sąjungos teisės aktus:
6. Susijusiu atklytu darninuj standartu nuorodos arba kitu techninuj specifikacijų, pagal laurus buvo deklaruota atbilstis, nuorodos:
7. Notifikuotoji įstaga w atliko x ir išdavė sertifikata y dėl z:
A. Papildoma informacija ():
A.1 Ženklinimas
A.2 Ženklinimas



CE-00049A

EU-Declaration of Conformity

MinebeaMitsumi
Passion to Create Value through Difference

latviešu valoda (lv)

Athibstības deklarācija

1. Produkta modeļa / produkta numurs / derīgs tikai projektam Nr.:
2. Ražotāja (2.1.) un tā pilnvarotā pārstāvja (2.2.) nosaukums un adrese:
3. Šī atbilstības deklarācija ir izdota vienīgi uz ražotāja atbildību.
4. Deklarācijas priekšmets vai priekšmeti:
5. Iepriekš apstiprinātās deklarācijas priekšmets vai priekšmeti atbilst attiecīgajam Savienības saskaņošanas tiesību aktam:
6. Atsaucies uz attiecīgajiem izmantojamiem saskaņotajiem standartiem vai uz citām tehniskajām specifikācijām, attiecībā uz ko tiek deklarēta atbilstība:
7. Paziņotā struktūra w ir veikusi x un izsniegusi sertifikātu y, kas attiecas uz z:
A. Papildu informācija par ():
A.1. Marķējums
A.2. Marķējums

malta (mt)

Dikjarazzjoni ta' konformità

1. Modell tal-prodott / numru tal-prodott / valida biss għan-numru tal-proġett:
2. L-isem u l-indirizz tal-manifattur (2.1) u tarappreżentant awtorizzat tiegħu (2.2):
3. Din id-dikjarazzjoni ta' konformità tinfahreg taħt ir-responsabbiltà unika tal-manifattur.
4. L-għan(jiet) tad-dikjarazzjoni:
5. L-għan(jiet) tad-dikjarazzjoni deskritt(i) haqqa fuq luha(l)hna konformi mal-legislazzjoni ta' armonizzazzjoni rilevanti tal-Unjoni:
6. Ir-referenzi għall-istandards armonizzati rilevanti li ntuzaw, jew ir-referenzi għallspeċifikazzjonijiet tekniċi l-oħra li skontom qed tigi ddikjarata l-konformità:
7. Il-korp notifikat w wettaq x u hareġ iċertifikat y rilevanti għal z:
A. Informazzjoni addizzjonali fuq ():
A.1. Immarkar
A.2. Immarkar

nederlands (nl)

Conformiteitsverklaring

1. Productmodel / productnummer / uitsluitend geldig voor projectnummer:
2. Naam en adres van de fabrikant (2.1) en zijn gemachtigde (2.2):
3. Deze conformiteitsverklaring wordt verstrekt onder volledige verantwoordelijkheid van de fabrikant.
4. Voorwerp(en) van de verklaring:
5. Het (de) hierboven beschreven voorwerp(en) is (zijn) in overeenstemming met de desbetreffende harmonisatiewetgeving van de Unie:
6. Vermelding van de toegepaste relevante geharmoniseerde normen of van de overige technische specificaties waarop de conformiteitsverklaring betrekking heeft:
7. De aangemelde instantie w heeft een x uitgevoerd en het certificaat y verstrekt dat relevant is voor z:
A. Aanvallende informatie over ():
A.1. Markering
A.2. Markering

polski (pl)

Deklaracja zgodności

1. Model produktu / numer produktu / ważny wyłącznie dla projektu o numerze:
2. Nazwa i adres producenta (2.1) oraz jego upoważnionego przedstawiciela (2.2):
3. Niniejsza deklaracja zgodności wydana zostaje na wyłączną odpowiedzialność producenta.
4. Przedmiot(-y) deklaracji:
5. Wymagania powyżej przedmiot (lub przedmiotów) niniejszej deklaracji jest zgodny z odpowiednimi wymaganiami unijnego prawodawstwa harmonizacyjnego:
6. Odwołania do odpowiednich norm zharmonizowanych, które zastosowano, lub do innych specyfikacji technicznych, w stosunku do których deklarowana jest zgodność:
7. Jednostka notyfikowana w przeprowadziła x i wydała certyfikat y i odpowiedni dla z:
A. Informacje dodatkowe o ():
A.1. Oznakowanie
A.2. Oznakowanie

português (pt)

Declaração de conformidade

1. Modelo do produto / número do produto / somente válido para o número de projeto:
2. Nome e endereço do fabricante (2.1) e do seu mandatário (2.2):
3. A presente declaração de conformidade é emitida sob a exclusiva responsabilidade do fabricante.
4. Objeto(s) da declaração:
5. O(s) objeto(s) da declaração acima descrito(s) está(ão) em conformidade com a legislação aplicável de harmonização da União:
6. Referências às normas harmonizadas aplicáveis utilizadas ou às outras especificações técnicas em relação às quais é declarada a conformidade:
7. O organismo notificado w realizou x e emitiu o certificado y relevante para z:
A. Informações complementares relativa a ():
A.1. Marcação
A.2. Marcação

română (ro)

Declarație de conformitate

1. Modelul de produs / Număr produs / valabil numai pentru numărul proiectului:
2. Denumirea și adresa producătorului (2.1) și a reprezentantului său autorizat (2.2):
3. Prezenta declarație de conformitate este emisă pe răspunderea exclusivă a producătorului.
4. Obiectul (obiectele) declarației:
5. Obiectul (obiectele) declarației descrise mai sus sunt în conformitate cu legislația relevantă de armonizare a Uniunii:
6. Trimiteri la standardele armonizate relevante folosite sau trimiteri la edelalte specificații tehnice în legătură cu care se declară conformitatea:
7. Organismul notificat w a efectuat x și a emis certificatul y corespunzător pentru z:
A. Informații suplimentare despre ():
A.1. Marcaj
A.2. Marcaj



EU-Declaration of Conformity

MinebeaMitsumi
Passion to Create Value through Difference

slovenčina (sk)

Vyhlasenie o zhode
1. Model výrobku / číslo výrobku / platné len pre číslo projektu:
2. Meno/názov a adresa výrobcu (2.1) a jeho splnomocneného zástupcu (2.2):
3. Toto vyhlásenie o zhode sa vydáva na vlastnú zodpovednosť výrobcu.
4. Predmet(-y) vyhlásenia:
5. Uvedený predmet si uvedený predmet vyhlásenia sú v zhode s príslušnými harmonizačnými právnyimi predpismi Únie:
6. Odkazy na príslušné použité harmonizované normy alebo odkazy na iné technické špecifikácie, v súvislosti s ktorými sa zhoda vyhlasuje:
7. Notifikovaný orgán v vykonal x a vydal certifikát y relevantný pre z:
A. Doplnujúce informácie o ():
A.1 Označenie
A.2 Označenie

slovenščina (sl)

Izjava o skladnosti
1. Model proizvoda / serijska številka proizvoda / veljavno samo za številko projekta:
2. Ime in naslov proizvajalca (2.1) ter njegovega pooblaščenega zastopnika (2.2):
3. Za izdajo te izjave o skladnosti je odgovoren izključno proizvajalec.
4. Predmet(i) izjave:
5. Predmet(i) navedene izjave je (so) v skladu z ustrežno zakonodajo Unije o harmonizaciji:
6. Sklicevanja na uporabljene ustrezne harmonizirane standarde ali sklicevanja na druge tehnične specifikacije v zvezi s skladnostjo, ki je navedena v izjavi:
7. Priglašeni organ w je izvedel x in izdal certifikat y, pomemben za z:
A. Dodatne informacije o ():
A.1 Oznaka
A.2 Oznaka

suomi (fi)

Vaatimustenmukaisuusvakuutus
1. Tuotemalli / tuotenumero / koskee vain projektinumeroa:
2. Valmistajan (2.1) ja valtuutetun edustajan (2.2) nimi ja osoite:
3. Tämä vaatimustenmukaisuusvakuutus on annettu valmistajan yksinomaisella vastuulla.
4. Vakuutuksen kohde (kohdet):
5. Edellä kuvattu (kuvattu) vakuutuksen kohde (kohdet) on (ovat) asiaa koskevan unionin yhdenmukaistamislaissäädännön vaatimusten mukainen (mukaisia):
6. Viittaus niihin asiaan koskeviin yhdenmukaistettuihin standardeihin, joita on läydetty, tai viittaus muihin tekniisin eritelmiin, joiden perusteella vaatimustenmukaisuusvakuutus on annettu:
7. Ilmoitettu laitos w suoritti x ja antoi todistuksen y liityen z:
A. Lisä tietoja ():
A.1 Merkintä
A.2 Merkintä

svenska (sv)

Försäkran om överensstämmelse
1. Produktmodell / produktnummer / gäller endast för projektnummer:
2. Tillverkarens namn och adress (2.1) och dess auktoriserade representant (2.2):
3. Denna försäkran om överensstämmelse utfärdas på tillverkarens eget ansvar.
4. Föremål för försäkran:
5. Föremålet/föremålen för försäkran ovan överensstämmer med den relevanta harmoniserade unionslagstiftningen:
6. Hänvisningar till de relevanta harmoniserade standarder som använts eller hänvisningar till de andra tekniska specifikationer enligt vilka överensstämmelsen försäkras:
7. Det anmälda organet w har utfört x och utfärdat intyget y relevant för z:
A. Ytterligare information om ():
A.1 Märkning
A.2 Märkning

8.2 UKCA-00008



UKCA-Declaration of Conformity

(in accordance with ISO/IEC 17050-1)



1. Product model / product number:
 - 1.1 Single Point Type Load Cell / PR 57, M050
2. Name and address of the manufacturer (2.1) and his authorized representative (2.2):
 - 2.1 MinebeaMitsumi Inc. Sensing Device Business Unit,
1-1-1 Katase, Fujisawa-shi, Kanagawa, Japan
 - 2.2 /
3. This declaration of conformity is issued under the sole responsibility of the manufacturer.
4. Object(s) of the declaration:
 - 4.1 PR 57-***** M050-*****N***
5. The object(s) of the declaration described above is (are) in conformity with the statutory requirements:
 - (4.1)
 - 5.1 S.I 2016 No. 1091 (6.1)
 - 5.2 S.I 2012 No. 3032 (6.2)
6. References to the relevant designated standards used or references to the other technical specifications in relation to which conformity is declared:
 - 6.1 S.I 2016 No. 1091 EN 61326-1:2013
 - 6.2 S.I 2012 No. 3032 EN IEC 63000:2018

MinebeaMitsumi Inc.
Fujisawa, 20 January, 2023

Satoshi Sato
Division Head

Satoshi Uchibori
UKCA Certification

8.3 17-012

 		Certificate Number: 17-012 Page 1 of 2
NATIONAL TYPE EVALUATION PROGRAM <i>Certificate of Conformance</i> <i>for Weighing and Measuring Devices</i>		
For: Load Cell Compression Model: M050 & PR57 Series n_{max} : 5000, Class III, Single Cell Capacity: 300 kg to 500 kg Accuracy Class: III	Submitted By: Minebea Mitsumi, Inc. 1-1-1, Katase Fujisawa, Kanagawa 251-8531 Japan Tel: +81 (0) 466 22 8703 Fax: +81 (0) 466 22 1701 Contact: Mr. Akira Murohashi Email: amurohashi@minebeamitsumi.com Web site: www.minebea-med.com	
Standard Features and Options		
<ul style="list-style-type: none"> • The specific load cell models, capacities and v_{min} values covered by this Certificate are listed in the table on Page 2. • Nominal output: 2.0 mV/V • Stainless Steel • 6 Wire Design • Minimum Dead Load: 0 kg 		
Temperature Range: -10 °C to 40 °C (14 °F to 104 °F)		
This device was evaluated under the National Type Evaluation Program and was found to comply with the applicable technical requirements of "NIST Handbook 44: Specifications, Tolerances and Other Technical Requirements for Weighing and Measuring Devices." Evaluation results and device characteristics necessary for inspection and use in commerce are on the following pages.		
 <hr/> Kristin Macey Chairman, NCWM, Inc.	 <hr/> Jerry Buendel Chairman, National Type Evaluation Program Committee Issued: January 30, 2017	
1135 M Street, Suite 110 / Lincoln, Nebraska 68508		
The National Conference on Weights and Measures (NCWM) does not approve, recommend or endorse any proprietary product or material, either as a single item or as a class or group. Results shall not be used in advertising or sales promotion to indicate explicit or implicit endorsement of the product or material by the NCWM.		



Certificate Number: 17-012
Page 2 of 2

Minebea Mitsumi Inc.

Load Cell / M050 & PR57 Series

Application: The load cells may be used in Class III scales for single cell applications consistent with the model designations, number of scale divisions, and parameters specified in this certificate. Load cells of a given accuracy class may be used in applications with lower accuracy class requirements provided the number of scale divisions, the v_{\min} value, and temperature range are suitable for the application. The manufacturer may market the load cell with fewer divisions (n_{\max}) and with greater v_{\min} values than those listed on the certificate. However, the load cells must be marked with the appropriate n_{\max} and v_{\min} for which the load cell may be used.

Specific Capacities and v_{\min} Values:

Models	Capacity	v_{\min} Class III Single Cell, n = 5000
M050 and PR57 Series	300 kg*	15 g (0.015 kg)
* load cell tested	500 kg	25 g (0.025 kg)

Identification: A pressure sensitive identification label located on the cell, states manufacturer name, model, serial number, NTEP Certificate number and rated capacity. Other pertinent information will be specified on the Calibration Certificate accompanying the cell.

Test Conditions: This certificate is issued based upon the following tests and upon information provided by the manufacturer. A 5 kg, and 300 kg capacity load cell were tested by the NMI Certain B.V. at The Netherlands facility. Testing was conducted in accordance with the OIML DoMC Mutual Acceptance Arrangement, signed by the NCWM as a utilizing participant for load cell testing. Testing was conducted using deadweights as the reference standard. The load cells were tested over a temperature range of -10 °C to 40 °C with tests run on each cell at each temperature. The temperature effect on zero was measured and a time dependence (creep) test was performed. The barometric pressure test to determine sensitivity of the load cell design to changes in barometric pressure was conducted. The data were analyzed for single load cell applications. OIML R60 selection criteria were used to determine cells tested.

Evaluated By: S.J. Koeman, M.M.J. Meyjer (NMI)

Type Evaluation Criteria Used: NIST, Handbook 44: Specifications, Tolerances and Other Technical Requirements for Weighing and Measuring Devices, 2017. NCWM, Publication 14: Weighing Devices, 2016.

Conclusion: The results of the evaluation and information provided by the manufacturer indicate the device complies with applicable requirements.

Information Reviewed By: J. Truex (NCWM)

Examples of Device:



8.4 10051

**Agriculture
and Markets**

10B Airline Drive
Albany, New York 12235
800-554-4501
www.agriculture.ny.gov

Certificate of Approval
for Weighing and Measuring Devices

New York State Certificate Number: 10051
Effective Date: December 28, 2017

NTEP Certificate of Conformance Number: 17-012

For:

Load Cell
Compression
Model: M050 & PR57 Series
n_{max}: 5000, Class III, Single Cell
Capacity: 300 kg to 500 kg
Accuracy Class: III

Submitted By:

Minebea Mitsumi, Inc.
1-1-1, Katase
Fujisawa, Kanagawa 251-8531
Japan
Tel: +81 (0) 466 22 8703
Fax: +81 (0) 466 22 1701
Contact: Mr. Akira Murohashi
Email: amurohashi@minebeamitsumi.com
Web site: www.minebea-mcd.com

This certifies that the items specified in the above National Type Evaluation Program (NTEP) Certificate of Conformance are hereby approved for sale or use in the State of New York.

The NTEP Certificate of Conformance, as issued by the National Conference on Weights and Measures, is accepted under the terms of 1NYCRR Part 220.1. Evaluation results and device characteristics necessary for inspection and use in commerce are stated in the NTEP Certificate of Conformance. Copies of the NTEP Certificate of Conformance are available on request and are available for inspection at the Bureau's Metrology Office at 6 Harriman Campus Road, Albany, NY 12206.

Michael Sikula, Director
NYS Bureau of Weights and Measures

8.5 R60/2000-NL1-17.29

	<h2>OIML Certificate of Conformity</h2>
OIML Member State The Netherlands	Number R60/2000-NL1-17.29 Project number 1900650 Page 1 of 2
Issuing authority	NMI Certin B.V. Person responsible: C. Oosterman
Applicant and Manufacturer	MinebeaMitsumi Inc. 1-1-1, Katase Fujisawa-shi, Kanagawa-ken 251-8531 Fujisawa Japan
Identification of the certified type	A single point load cell , with strain gauges. Type : M050 or PR57
Characteristics	See next page
<p>This Certificate attests the conformity of the above identified Type (represented by the sample(s) identified in the OIML Test Report) with the requirements of the following Recommendation of the International Organization of Legal Metrology (OIML):</p>	
OIML R60 - Edition 2000 (E) for accuracy class C	
<p>This Certificate relates only to the metrological and technical characteristics of the type of measuring instrument covered by the relevant OIML International Recommendation above-identified. This Certificate does not bestow any form of legal international approval.</p>	
<p><i>Important note:</i> Apart from the mention of the Certificate's reference number and the name of the OIML Member State in which the Certificate was issued, partial quotation of the Certificate and of the associated OIML Test Report(s) is not permitted, although either may be reproduced in full.</p>	
Issuing Authority	NMI Certin B.V., OIML Issuing Authority NL1 17 March 2017
 C. Oosterman Head Certification Board	
NMI Certin B.V. Hugo de Grootplein 1 3314 EG Dordrecht the Netherlands T +31 78 6332332 certin@nmi.nl www.nmi.nl	<p>This document is issued under the provision that no liability is accepted and that the applicant shall indemnify third-party liability.</p> <p>The notification of NMI Certin B.V. as Issuing Authority can be verified at www.oiml.org</p>
 	



OIML Certificate of Conformity

OIML Member State
The Netherlands

Number R60/2000-NL1-17.29
Project number 1900650
Page 2 of 2

The conformity was established by the results of tests and examinations provided in the associated OIML Test Report(s):

- No. NMI-16200725-01 dated 5 January 2017 that includes 51 pages.

Characteristics of the load cell:

Maximum capacity (E_{max})	300 kg up to and including 500 kg
Minimum dead load	0 kg
Accuracy Class	C
Rated Output	2,0 mV/V
Maximum number of load cell intervals (n)	3000
Ratio of minimum LC Verification interval $Y = E_{max} / v_{min}$	20000
Ratio of minimum dead load output return $Z = E_{max} / (2 * DR)$	3000
Input impedance	$380 \Omega \pm 38 \Omega$
Temperature range	-10 °C / + 40 °C
Fraction p_{LC}	0,7
Humidity Class	CH
Safe overload	150 % of E_{max}
Output impedance	$350 \Omega \pm 25 \Omega$
Recommended excitation	12 V AC / DC
Excitation maximum	15 V AC / DC
Transducer material	Stainless steel
Atmospheric protection	Silicon rubber

The characteristics for n_{max} and Y can be reduced separately.

Each produced load cell is provided with an accompanying document with information about its characteristics.

The above identified Type (represented by the sample(s) identified in the OIML Test Report) have been found to comply with the additional national requirements established by the United States of America (NIST Handbook 44 and NCWM Publication 14), included in the MAA Declaration of Mutual Confidence:

- R 60 DoMC-01 rev.0, Additional requirements from the United States;
- R 60 DoMC-02 rev.0, Additional requirements from the United States.

8.6 TC10952

	<h2 style="text-align: center;">Test Certificate Parts Certificate</h2>
	<p style="text-align: right;">Number TC10952 revision 0 Project number 16200725 Page 1 of 1</p>
Issued by	NMI Certin B.V.
In accordance with	WELMEC 8.8 Issue 2, WELMEC 2.4 Issue 2, OIML R 60 (2000), EN 45501:2015.
Producer	MINEBEA CO., LTD. 1-1-1, Katase Fujisawa-shi, Kanagawa-ken 251-8531 Fujisawa Japan
Measuring instrument	A single point load cell , with strain gauges, tested as a part of a weighing instrument.
	Brand : Minebea Designation : M050 or PR57
	Further properties are described in the annexes: - Description TC10952 revision 0; - Documentation folder TC10952-1.
	An overview of performed tests is given in the annex: - Description TC10952 revision 0.
Issuing Authority	NMI Certin B.V. 5 January 2017
	 C. Gosterman Head Certification Board
NMI Certin B.V. Hugo de Grootplein 1 3314 EG Dordrecht The Netherlands T +31 78 6332332 certin@nmi.nl www.nmi.nl	This document is issued under the provision that no liability is accepted and that the producer shall indemnify third-party liability.
	Reproduction of the complete document only is permitted
	 INSPECTION RvA 1122



Description

Number **TC10952** revision 0
 Project number 16200725
 Page 1 of 2

1 General information about the load cell

All properties of the load cell, whether mentioned or not, shall not be in conflict with the standards mentioned in this certificate.

This certificate is the positive result of the applied voluntary, modular approach, for a component of a measuring instrument, as described in WELMEC 8.8. The complete measuring system must be covered by an EC type-approval certificate, an EC-type examination certificate or an EU-type examination certificate.

1.1 Essential parts

Number	Pages	Description	Remark
10952/0-01	1	M050, PR57 load cell outline	Mechanical and electrical

Cable:

- The load cell is provided with a 6-wire system (=“Remote-sensing”):
 - The cable length is not limited.

The cable shall be a shielded cable, the shield is connected to the load cell.

1.2 Essential characteristics

Maximum capacity (E_{max})	300 kg up to and including 500 kg
Minimum dead load	0 kg
Accuracy Class	C
Rated Output	2,0 mV/V
Maximum number of load cell intervals (n)	3000
Ratio of minimum LC Verification interval $Y = E_{max} / v_{min}$	20000
Ratio of minimum dead load output return $Z = E_{max} / (2 * DR)$	3000
Input impedance	$380 \Omega \pm 38 \Omega$
Temperature range	-10 °C / + 40 °C
Fraction p_{LC}	0,7
Humidity Class	CH
Safe overload	150 % of E_{max}
Output impedance	$350 \Omega \pm 25 \Omega$
Recommended excitation	12 V AC / DC
Excitation maximum	15 V AC / DC



Description

Number **TC10952** revision 0
Project number 16200725
Page 2 of 2

Transducer material	Stainless steel
Atmospheric protection	Silicon rubber

The characteristics for n_{max} and Y can be reduced separately.

Each produced load cell is provided with an accompanying document with information about its characteristics.

1.3 Essential shapes

Number	Pages	Description	Remark
10952/0-01	1	M050, PR57 load cell outline	Mechanical and electrical

The descriptive markings plate is secured against removal by sealing or will be destroyed when removed and contains at least the information and markings as described in OIML R 60 (2000) and:

- This certificate number TC10952 (in the countries where it is mandatory);
- Producers name or mark.

2 Seals

The connecting cable of the load cell or the junction box is provided with possibility to seal.

3 Conditions for conformity assessment

The compatibility of load cells and indicator is established by the manufacturer by means of the compatibility of modules form, contained in WELMEC 2, 2015 clause 10, at the time of putting into use.

Other parties may use this certificate without the written permission of the producer (WELMEC 8.8).

4 Reports

An overview of performed tests is given in the reports:

- No. NMI-16200725-01 dated 5 January 2017 that includes 51 pages.

A report can be a test report, an evaluation report, a type evaluation report and/or a pattern evaluation report.

8.7 BVS 21 ATEX E 023X

1 EU-Baumusterprüfbescheinigung

**2 Geräte zur bestimmungsgemäßen Verwendung in explosionsgefährdeten Bereichen
Richtlinie 2014/34/EU**

3 Nr. der EU-Baumusterprüfbescheinigung: **BVS 21 ATEX E 023 X**

4 Produkt: **Wägezellen Typ M****.***** alternativ Typ PR **.*******

5 Hersteller: **Minebea Mitsumi Inc.**

6 Anschrift: **1-1-1 Katase Fujisawa, Kanagawa, Japan**

7 Die Bauart dieses Produktes sowie die verschiedenen zulässigen Ausführungen sind in der Anlage zu dieser Baumusterprüfbescheinigung festgelegt.

8 Die Zertifizierungsstelle der DEKRA Testing and Certification GmbH, benannte Stelle Nr. 0158 gemäß Artikel 17 der Richtlinie 2014/34/EU des Europäischen Parlaments und des Rates vom 26. Februar 2014, bescheinigt, dass das Produkt die wesentlichen Gesundheits- und Sicherheitsanforderungen für die Konzeption und den Bau von Produkten zur bestimmungsgemäßen Verwendung in explosionsgefährdeten Bereichen gemäß Anhang II der Richtlinie erfüllt. Die Ergebnisse der Prüfung sind in dem vertraulichen Prüfprotokoll BVS PP 21.2035 EU niedergelegt.

9 Die wesentlichen Gesundheits- und Sicherheitsanforderungen werden erfüllt unter Berücksichtigung von:



EN IEC 60079-0:2018	Allgemeine Anforderungen
EN IEC 60079-7:2015 + A1:2018	Erhöhte Sicherheit „e“
EN 60079-11:2012	Eigensicherheit „i“
EN 60079-31:2014	Schutz durch Gehäuse „t“

mit Ausnahme der Anforderungen, die in Abschnitt 18 der Anlage aufgeführt werden.

10 Falls das Zeichen „X“ hinter der Bescheinigungsnummer steht, wird in der Anlage zu dieser Bescheinigung auf besondere Bedingungen für die sichere Anwendung des Produktes hingewiesen.

11 Diese EU-Baumusterprüfbescheinigung bezieht sich nur auf den Entwurf und Bau der beschriebenen Produkte.
Für den Herstellungsprozess und die Abgabe der Produkte sind weitere Anforderungen der Richtlinie zu erfüllen, die nicht durch diese Bescheinigung abgedeckt sind.

12 Die Kennzeichnung des Produktes muss die folgenden Angaben enthalten:

	II 1G Ex ia IIC T6/T4 Ga	M****.***** 0 *** alternativ
	II 1D Ex ia IIIC T₂₀₀165°C Da	PR **.***** E
	II 3G Ex ec IIC T6/T4 Gc	M****.***** 2 *** alternativ
	II 2D Ex tb IIIC T110°C Db	PR **.*****

DEKRA Testing and Certification GmbH
Bochum, 07.06.2021

Geschäftsführer



Seite 1 von 4 zu BVS 21 ATEX E 023 X – Jobnumber 341428900
Dieses Zertifikat darf nur vollständig und unverändert weiterverbreitet werden.

DEKRA Testing and Certification GmbH, Handwerkstraße 15, 70565 Stuttgart
Zertifizierungsstelle: Dinnendahlstraße 9, 44809 Bochum
Telefon +49 234.3696-400, Fax +49.234.3696-401, DTC-Certification-body@dekra.com



13 **Anlage zur**

14 **EU-Baumusterprüfbescheinigung**

BVS 21 ATEX E 023 X

15 **Beschreibung des Produktes**

15.1 **Gegenstand und Typ**

Wägezellen Typ M***-**** * * * *

Stern	Bedeutung
1+2	Typ der Wägezelle M010, M020, M030, M040, M050, M060, M070, M080, M090, M100, M110, M130
3-6	Kapazität der Wägezelle in kg (Abhängig vom jeweiligen Typ) 0005 5 kg 07.5 7,5 kg 5099 5099 kg
7	Genauigkeit (nicht Ex-relevant)
8	Ex Schutz 0 Einsatz in Zone 0 und 20 2 Einsatz in Zone 2 und 21
9+10	Länge der fest angeschlossenen Leitung in Meter (Abhängig vom jeweiligen Typ)
11	Nicht Ex-relevant

Alternativ Typ PR **-**** * * * *

Stern	Bedeutung
1+2	Typ der Wägezelle PR 40, PR 43, PR 54, PR 44, PR 57, PR 47, PR 53, PR 55, PR 58, PR 77, PR 79, PR 78
3-6	Kapazität der Wägezelle (Abhängig vom jeweiligen Typ) 0005 5 kg 07.5 7,5 kg 5099 5099 kg
7-8	Einheit der Kapazität [kg] oder [t]
9	Ex Schutz E Einsatz in Zone 0 und 20 ohne Einsatz in Zone 2 und 21

Seite 2 von 4 zu BVS 21 ATEX E 023 X – Jobnumber 341428900
Dieses Zertifikat darf nur vollständig und unverändert weiterverbreitet werden.

DEKRA Testing and Certification GmbH, Handwerkstraße 15, 70565 Stuttgart
Zertifizierungsstelle: Dinnendahlstraße 9, 44809 Bochum
Telefon +49.234.3696-400, Fax +49.234.3696-401, DTC-Certification-body@dekra.com



15.2 Beschreibung
 Die Wägezellen Typ M***-**** * 0 ** * alternativ Typ PR **-**** ** 0 sind für den Einsatz in Zone 0 und Zone 20 (EPL Ga und Da) in der Zündschutzart Eigensicherheit „i“ ausgeführt. Die Wägezellen Typ M***-**** * 2 ** * alternativ Typ PR **-**** ** 2 sind für den Einsatz in Zone 2 und Zone 21 (EPL Gc und Db) in den Zündschutzarten Erhöhte Sicherheit „ec“ und Schutz durch Gehäuse „tb“ ausgeführt.

Die Wägezellen bestehen aus einem massiven Metallblock, welcher mit Dehnungsmessstreifen versehen ist. Abhängig vom jeweiligen Typ werden die Dehnungsmessstreifen entweder komplett vergossen oder der Raum wird mit einem Metallstopfen gasdicht verschweißt.

Das Metallgehäuse der Typen M010, PR 40, M020, PR 43, M040, PR 44, M060 und PR 47 besteht aus Aluminium.

Das Metallgehäuse der Typen M030, PR 54, M050, PR 57, M070, PR 53, M080, PR 55, M090, PR 58, M100, PR 77, M110, PR 79, M130 und PR 78 besteht aus Chrom-Nickel-Stahl.

Der Anschluss erfolgt über die fest angeschlossenen Leitungen, die direkt in den vergossenen oder verschweißten Raum führen. Die Farbe des Leitungsmantels ist immer grün. Bei den eigensicheren Typen wird zur Kennzeichnung ein blauer Schrumpfschlauch verwendet. Die Einführung erfolgt über eine eigenproduzierte Kabel- und Leitungseinführung die auch Gegenstand dieser Baumusterprüfung ist.

Auflistung aller verwendeten Komponenten mit älterem Normenstand

Keine

15.3 Kenngrößen

Nicht eigensichere Kenngrößen (Typ M***-**** * 2 ** * / PR **-**** **)

Bemessungsspannung		30	VDC
Bemessungsstrom		500	mA
Bemessungsleistung		3,1	W

Eigensichere Kenngrößen (Typ M***-**** * 0 ** * / PR **-**** ** E)

Maximale Eingangsspannung	U _i	30	VDC
Maximaler Eingangsstrom	I _i	500	mA
Maximale Eingangsleistung	P _i	1,8	W für T6 (Typ PR53)
		1,95	W für T6 (alle anderen Typen)
		4	W für T4 (alle Typen)

Die Wägezellen enthalten keine konzentrierten Kapazitäten oder Induktivitäten.

Maximale innere Kapazität	C _i	130	pF / m
Maximale innere Induktivität	L _i	0,95	µH / m

Thermische Kenngrößen

Umgebungstemperaturbereich / Temperaturklasse / Oberflächentemperatur
 -30 °C ≤ T_{amb} ≤ 40 °C (T6)
 -30 °C ≤ T_{amb} ≤ 70 °C (T4 und Staub)

16 Prüfprotokoll

BVS PP 21.2035 EU, Stand 07.06.2021



Seite 3 von 4 zu BVS 21 ATEX E 023 X – Jobnummer 341428900
 Dieses Zertifikat darf nur vollständig und unverändert weiterverbreitet werden.
 DEKRA Testing and Certification GmbH, Handwerkstraße 15, 70565 Stuttgart
 Zertifizierungsstelle: Dinnendahlstraße 9, 44809 Bochum
 Telefon +49.234.3696-400, Fax +49.234.3696-401, DTC-Certification-body@dekra.com



17 **Besondere Bedingungen für die Verwendung**

17.1.1 Das Gerät ist für einen Umgebungstemperaturbereich von -30 °C bis 40 °C in der Temperaturklasse T6 und einem Umgebungstemperaturbereich von -30 °C bis 70 °C in der Temperaturklasse T4 oder für Staubanwendungen geeignet

17.1.2 Für den Einsatz in EPL Ga müssen die Geräte so installiert werden, dass Zündgefahren durch Schlag- oder Reibungsfunken ausgeschlossen werden können.

17.1.3 Die Kabelverschraubungen wurden mit einer reduzierten Zugkraft gemäß Abschnitt A.3.1 der EN IEC 60079-0 geprüft und dürfen nur mit fester Installation verwendet werden. Der Anwender hat für eine ausreichende Befestigung des Kabels zu sorgen.

17.1.4 Hohe oder wiederkehrende Aufladungsprozesse müssen für den Einsatz in EPL Ga ausgeschlossen werden.

17.1.5 Die nichtmetallischen Oberflächen der Wägezellen müssen durch die Installation vor mechanischen Gefährdungen geschützt werden.

18 **Wesentliche Gesundheits- und Sicherheitsanforderungen**

Die wesentlichen Gesundheits- und Sicherheitsanforderungen sind durch die unter Abschnitt 9 gelisteten Normen abgedeckt.
In Ergänzung zu den wesentlichen Gesundheits- und Sicherheitsanforderungen, die durch die unter Abschnitt 9 gelisteten Normen abgedeckt werden, wurden folgende Anforderungen betrachtet und die Übereinstimmung in dem Prüfbericht nachgewiesen:

Die im Anhang verwendete Norm IEC 60079-7:2015 Ed. 5.1 ist technisch gleichwertig zu der auf der 1. Seite aufgelisteten EN IEC Norm.
Die im Anhang verwendete Norm IEC 60079-0:2017 Ed. 7 ist technisch gleichwertig zu der auf der 1. Seiten aufgelisteten EN IEC-Norm. Für dieses Produkt ist die Norm sicherheitstechnisch gleichwertig zur harmonisierten Norm EN IEC 60079-0:2018. Die Kennzeichnung entspricht der Richtlinie 2014/34/EU (siehe Abschnitt 5 dieses Prüfprotokolls).

19 **Zeichnungen und Unterlagen**

Die Zeichnungen und Unterlagen sind in dem vertraulichen Prüfprotokoll gelistet.

Seite 4 von 4 zu BVS 21 ATEX E 023 X – Jobnumber 341428900
Dieses Zertifikat darf nur vollständig und unverändert weiterverbreitet werden.

 Dakks
DIN EN ISO 9001
01/171343-00

DEKRA Testing and Certification GmbH, Handwerkstraße 15, 70565 Stuttgart
Zertifizierungsstelle: Dinnendahlstraße 9, 44809 Bochum
Telefon +49.234.3696-400, Fax +49.234.3696-401, DTC-Certification-body@dekra.com



Translation

1 EU-Type Examination Certificate

2 **Equipment intended for use in potentially explosive atmospheres**
Directive 2014/34/EU

3 EU-Type Examination Certificate Number: **BVS 21 ATEX E 023 X**

4 Product: **Load cell type M***.**** * * * * alternatively type PR **.**** * * ***

5 Manufacturer: **Minebea Mitsumi Inc.**

6 Address: **1-1-1 Katase Fujisawa, Kanagawa, Japan**

7 This product and any acceptable variations thereto are specified in the appendix to this certificate and the documents referred to therein.

8 DEKRA Testing and Certification GmbH, Notified Body number 0158, in accordance with Article 17 of Directive 2014/34/EU of the European Parliament and of the Council, dated 26 February 2014, certifies that this product has been found to comply with the Essential Health and Safety Requirements relating to the design and construction of products intended for use in potentially explosive atmospheres given in Annex II to the Directive.
The examination and test results are recorded in the confidential Report No. BVS PP 21.2035 EU.

9 The Essential Health and Safety Requirements are assured in consideration of:



<p>EN IEC 60079-0:2018 EN IEC 60079-7:2015 + A1:2018 EN 60079-11:2012 EN 60079-31:2014</p>	<p>General requirements Increased Safety "e" Intrinsic Safety "i" Protection by Enclosure "t"</p>
--	---

Except in respect of those requirements listed under item 18 of the appendix.

10 If the sign "X" is placed after the certificate number, it indicates that the product is subject to the Special Conditions for Use specified in the appendix to this certificate.

11 This EU-Type Examination Certificate relates only to the design and construction of the specified product. Further requirements of the Directive apply to the manufacturing process and supply of this product. These are not covered by this certificate.

12 The marking of the product shall include the following:

<p> II 1G Ex ia IIC T6/T4 Ga</p> <p> II 3G Ex ec IIC T6/T4 Gc</p>	<p>II 1D Ex ia IIIC T₂₀₀165°C Da</p> <p>II 2D Ex tb IIIC T110°C Db</p>	<p>M***.**** * 0 * * * * alternatively PR **.**** * * E</p> <p>M***.**** * 2 * * * * alternatively PR **.**** * *</p>
---	---	---

DEKRA Testing and Certification GmbH
Bochum, 2021-06-07

Signed: Jörg-Timm Kilisch

Managing Director

Page 1 of 4 of BVS 21 ATEX E 023 X – Jobnumber 341428900
This certificate may only be reproduced in its entirety and without any change.

DEKRA Testing and Certification GmbH, Handwerksstr. 15, 70565 Stuttgart, Germany
Certification body: Dinnendahlstr. 9, 44809 Bochum, Germany
Phone +49.234.3696-400, Fax +49.234.3696-401, e-mail DTC-Certification-body@dekra.com

DEKRA

13 **Appendix**

14 **EU-Type Examination Certificate**

BVS 21 ATEX E 023 X

15 **Product description**

15.1 **Subject and type**

Load cell type M***-*****

Asterisk	Description
1+2	Type of load cell M010, M020, M030, M040, M050, M060, M070, M080, M090, M100, M110, M130
3-6	Capacity of the load cell in kg (depending on the type) 0005 5 kg 07.5 7.5 kg 5099 5099 kg
7	Accuracy (not Ex-relevant)
8	Ex protection 0 Useable in Zone 0 and 20 2 Useable in Zone 2 and 21
9+10	Length of the permanently attached supply line in meter (depending on the type)
11	Not Ex-relevant

Alternatively type PR **-*****

Asterisk	Description
1+2	Type of load cell PR 40, PR 43, PR 54, PR 44, PR 57, PR 47, PR 53, PR 55, PR 58, PR 77, PR 79, PR 78
3-6	Capacity of the load cell (depending on the type)
7-8	Unit of the capacity value [kg] or [t]
9	Ex protection E Useable in Zone 0 and 20 w/o Useable in Zone 2 and 21

Page 2 of 4 of BVS 21 ATEX E 023 X – Jobnumber 341428900
This certificate may only be reproduced in its entirety and without any change.

DAkkS
DEKRA Testing and Certification GmbH, Handwerkstr. 15, 70565 Stuttgart, Germany
Certification body: Dinnendahlstr. 9, 44809 Bochum, Germany
Phone +49.234.3696-400, Fax +49.234.3696-401, e-mail DTC-Certification-body@dekra.com



15.2 Description

The load cells type M***.*** ** 0 *** alternatively type PR **.*** ** 0 are designed for use in zone 0 and zone 20 (EPL Ga and Da) in the type of protection intrinsic safety "i". The load cells type M***.*** ** 2 *** alternatively type PR **.*** ** 2 are designed for use in zone 2 and zone 21 (EPL Gc and Db) in the type of protection increased safety "ec" and protection by enclosure "tb".

The load cells consist of a solid metal block, which is provided with strain gauges. Depending on the type, the strain gauges are either completely encapsulated or the space is welded gas-tight with a metal plug.

The metal housing of types M010, PR 40, M020, PR 43, M040, PR 44, M060 and PR 47 is made of aluminium.

The metal housing of types M030, PR 54, M050, PR 57, M070, PR 53, M080, PR 55, M090, PR 58, M100, PR 77, M110, PR 79, M130 and PR 78 is made of chrome-nickel steel.

The connection is made through the fixed conductors, which lead directly into the potted or welded compartment. The colour of the cable sheath is always green. In the case of intrinsically safe types, a blue heat-shrinkable sleeve is used for identification. The entry is made via an own-produced cable gland for cables and conductors, which is also the subject of this type test.

Listing of all components used referring to older standards
None

15.3 Parameters

Non-intrinsically safe parameters (type M***.*** ** 2 *** / PR **.*** **)

Rated voltage		30	VDC
Rated current		500	mA
Rated power		3.1	W

Intrinsically safe parameters (type M***.*** ** 0 *** / PR **.*** ** E)

Maximum input voltage	U _i	30	VDC
Maximum input current	I _i	500	mA
Maximum input power	P _i	1.8	W for T6 (type PR53)
		1.95	W for T6 (all other types)
		4	W for T4 (all types)
The load cells do not contain any concentrated capacitances or inductances.			
Maximum internal capacitance	C _i	130	pF / m
Maximum internal inductance	L _i	0,95	µH / m

Thermal parameters
Ambient temperature range / Temperature class / Surface temperature

-30 °C ≤ T_{amb} ≤ 40 °C (T6)
-30 °C ≤ T_{amb} ≤ 70 °C (T4 and dust)

16 Report Number
BVS PP 21.2035 EU, as of 2021-06-07

17 Special Conditions for Use

17.1 The equipment is suitable for an ambient temperature range from -30 °C up to 40 °C for temperature class T6 and an ambient temperature range from -30 °C up to 70 °C for temperature class T4 or dust applications.

17.2 The equipment has to be installed in such a way that any ignition hazards caused by impact or friction can be excluded for use in EPL Ga.

Page 3 of 4 of BVS 21 ATEX E 023 X – Jobnumber 341428900
This certificate may only be reproduced in its entirety and without any change.



DEKRA Testing and Certification GmbH, Handwerkstr. 15, 70565 Stuttgart, Germany
Certification body: Dinnendahlstr. 9, 44809 Bochum, Germany
Phone +49.234.3696-400, Fax +49.234.3696-401, e-mail DTC-Certification-body@dekra.com

17.3 The cable glands have been tested with a reduced tensile force according to section A.3.1 of EN IEC 60079-0 and may only be used with fixed installation. The user must ensure that the cable is sufficiently secured.

17.4 High or repeating charging processes must be excluded for use in EPL Ga.

17.5 The non-metallic surfaces of the load cells must be protected from mechanical hazards by the installation.

18 Essential Health and Safety Requirements

The Essential Health and Safety Requirements are covered by the standards listed under item 9. In addition to the Essential Health and Safety Requirements are covered by the standards listed under item 9, the following are considered relevant to this product, and conformity is demonstrated in the report:

The standard IEC 60079-7:2015 Ed. 5.1 used in the annex is technically identical to the EN Standard listed on the front page.

The standard IEC 60079-0:2017 Ed. 7 used in the annex is technically identical to the EN IEC standard listed on the front page. For this product is the standard IEC 60079-0:2017 in terms of safety equivalent to the harmonized standard EN IEC 60079-0:2018. The marking meets the requirements of Directive 2014/34/EU (see clause 5 of this Test Report).

19 Drawings and Documents

Drawings and documents are listed in the confidential report.

We confirm the correctness of the translation from the German original.
In the case of arbitration only the German wording shall be valid and binding.



DEKRA Testing and Certification GmbH
Bochum, 2021-06-07
BVS-Hil/Kir A20190777



Managing Director

Page 4 of 4 of BVS 21 ATEX E 023 X – Jobnumber 341428900
This certificate may only be reproduced in its entirety and without any change.

 DEKRA Testing and Certification GmbH, Handwerkstr. 15, 70565 Stuttgart, Germany
Certification body: Dimmendahlstr. 9, 44809 Bochum, Germany
Phone +49.234.3696-400, Fax +49.234.3696-401, e-mail DTC-Certification-body@dekra.com

8.8 IECEx BVS 21.0024X

		<h2>IECEx Certificate of Conformity</h2>	
INTERNATIONAL ELECTROTECHNICAL COMMISSION IEC Certification System for Explosive Atmospheres <small>for rules and details of the IECEx Scheme visit www.iecex.com</small>			
Certificate No.:	IECEx BVS 21.0024X	Page 1 of 3	Certificate history:
Status:	Current	Issue No: 0	
Date of Issue:	2021-06-10		
Applicant:	MinebeaMitsumi Inc. 1-1-1 Katase Fujisawa-shi Kanagawa, 251-8531 Japan		
Equipment:	Load cell type M***-**** * * * * alternatively type PR **-**** * * *		
Optional accessory:			
Type of Protection:	Intrinsic Safety "i"; Protection by enclosure "t"; Increased Safety "e"		
Marking:	M***-**** * 0 * * * alternatively PR **-**** * * Ex ia IIC T6/T4 Ga Ex ia IIIC T₂₀₀165°C Da M***-**** * 2 * * * alternatively PR **-**** * * Ex ec IIC T6/T4 Gc Ex tb IIIC T110°C Db		
Approved for issue on behalf of the IECEx Certification Body:		Jörg Koch	
Position:		Head of Certification Body	
Signature: (for printed version)		_____	
Date:		_____	
1. This certificate and schedule may only be reproduced in full. 2. This certificate is not transferable and remains the property of the issuing body. 3. The Status and authenticity of this certificate may be verified by visiting www.iecex.com or use of this QR Code.			
Certificate issued by: DEKRA Testing and Certification GmbH Certification Body Dinnendahlstrasse 9 44809 Bochum Germany		  DEKRA On the safe side.	

		<h2 style="margin: 0;">IECEX Certificate of Conformity</h2>	
Certificate No.:	IECEX BVS 21.0024X	Page 2 of 3	
Date of issue:	2021-06-10	Issue No: 0	
Manufacturer:	MinebeaMitsumi Inc. 1-1-1 Katase Fujisawa-shi Kanagawa, 251-8531 Japan		
Additional manufacturing locations:	NMB-Minebea Thai Ltd. 5/2 Moo 8 Phaholyothin Road Km.149 T. Nikom Sang Ton-Eng A.Muang Lopburi Province 15000 Thailand	Minebea Electronics & Hi-tech Components (Shanghai) Ltd. No.5202 Lian Xi Rd. Jinze Town Qingpu District Shanghai 201721 China	
<p>This certificate is issued as verification that a sample(s), representative of production, was assessed and tested and found to comply with the IEC Standard list below and that the manufacturer's quality system, relating to the Ex products covered by this certificate, was assessed and found to comply with the IECEX Quality system requirements. This certificate is granted subject to the conditions as set out in IECEX Scheme Rules, IECEX 02 and Operational Documents as amended</p>			
<p>STANDARDS : The equipment and any acceptable variations to it specified in the schedule of this certificate and the identified documents, was found to comply with the following standards</p>			
IEC 60079-0:2017 Edition:7.0	Explosive atmospheres - Part 0: Equipment - General requirements		
IEC 60079-11:2011 Edition:6.0	Explosive atmospheres - Part 11: Equipment protection by intrinsic safety "I"		
IEC 60079-31:2013 Edition:2	Explosive atmospheres - Part 31: Equipment dust ignition protection by enclosure "t"		
IEC 60079-7:2017 Edition:5.1	Explosive atmospheres - Part 7: Equipment protection by increased safety "e"		
<p>This Certificate does not indicate compliance with safety and performance requirements other than those expressly included in the Standards listed above.</p>			
<p>TEST & ASSESSMENT REPORTS: A sample(s) of the equipment listed has successfully met the examination and test requirements as recorded in:</p>			
<p>Test Report: DE/BVS/ExTR21.0028/00</p>			
<p>Quality Assessment Reports: NL/DEK/QAR17.0006/02 NL/DEK/QAR17.0007/02 NL/DEK/QAR17.0008/02</p>			

		<h2>IECEX Certificate of Conformity</h2>	
Certificate No.:	IECEX BVS 21.0024X	Page 3 of 3	
Date of issue:	2021-06-10	Issue No: 0	
EQUIPMENT:			
Equipment and systems covered by this Certificate are as follows:			
Subject and Type			
See Annex			
Listing of all components used referring to older standards			
None			
Description			
<p>The load cells type M***-**** * 0 *** alternatively type PR **-**** ** E are designed for use in zone 0 and zone 20 (EPL Ga and Da) in the type of protection intrinsic safety "i". The load cells type M***-**** * 2 *** alternatively type PR **-**** ** are designed for use in zone 2 and zone 21 (EPL Gc and Db) in the type of protection increased safety "ec" and protection by enclosure "tb".</p> <p>The load cells consist of a solid metal block, which is provided with strain gauges. Depending on the type, the strain gauges are either completely encapsulated or the space is welded gas-tight with a metal plug.</p> <p>The metal housing of types M010, PR 40, M020, PR 43, M040, PR 44, M060 and PR 47 is made of aluminium.</p> <p>The metal housing of types M030, PR 54, M050, PR 57, M070, PR 53, M080, PR 55, M090, PR 58, M100, PR 77, M110, PR 79, M130 and PR 78 is made of chrome-nickel steel.</p>			
Parameters			
See Annex			
SPECIFIC CONDITIONS OF USE: YES as shown below:			
1 Special conditions for use to be listed in EU Type Examination Certificate			
1.1 The equipment is suitable for an ambient temperature range from -30 °C up to 40 °C for temperature class T6 and an ambient temperature range from -30 °C up to 70 °C for temperature class T4 or dust applications.			
1.2 The equipment has to be installed in such a way that any ignition hazards caused by impact or friction can be excluded for use in EPL Ga.			
1.3 The cable glands have been tested with a reduced tensile force according to section A.3.1 of IEC 60079-0 and may only be used with fixed installation. The user must ensure that the cable is sufficiently secured.			
1.4 High or repeating charging processes must be excluded for use in EPL Ga.			
1.5 The non-metallic surfaces of the load cells must be protected from mechanical hazards by the installation.			
2 Additional special conditions for use			
2.1 When used in gas group IIC, the permanently connected wire must be additionally protected against manual charging. Note included in the safety instructions, warning information on electrostatic discharge included on the type plate.			
Annex:			
BVS_21_0024X_Minebea_Annex.pdf			



IECEX Certificate of Conformity



Certificate No.: IECEX BVS 21.0024X
Annex
 Page 1 of 1

Subject and Type

Load cell type M***-**** * * * * *

- Asterisk Description
- 1+2 Type of load cell
M010, M020, M030, M040, M050, M060, M070, M080, M090, M100, M110, M130
- 3-6 Capacity of the load cell in kg (depending on the type)
0005 5 kg
07.5 7.5 kg
5099 5099 kg
- 7 Accuracy (not Ex-relevant)
- 8 Ex protection
0 Useable in Zone 0 and 20
2 Useable in Zone 2 and 21
- 9+10 Length of the permanently attached supply line in meter (depending on the type)
- 11 Not Ex-relevant

Alternatively type PR **-**** * * *

- Asterisk Description
- 1+2 Type of load cell
PR 40, PR 43, PR 54, PR 44, PR 57, PR 47, PR 53, PR 55, PR 58, PR 77, PR 79, PR 78
- 3-6 Capacity of the load cell (depending on the type)
- 7-8 Unit of the capacity value [kg] or [t]
- 9 Ex protection
E Useable in Zone 0 and 20
w/o Useable in Zone 2 and 21

Parameters

Non-intrinsically safe parameters (type M***-**** * 2 ** * / PR **-**** * *)

Rated voltage		30	VDC
Rated current		500	mA
Rated power		3.1	W

Intrinsically safe parameters (type M***-**** * 0 ** * / PR **-**** * * E)

Maximum input voltage	U _i	30	VDC
Maximum input current	I _i	500	mA
Maximum input power	P _i	1.8	W for T6 (type PR53)
		1.95	W for T6 (all other types)
		4	W for T4 (all types)
The load cells do not contain any concentrated capacitances or inductances.			
Maximum internal capacitance	C _i	130	pF / m
Maximum internal inductance	L _i	0,95	µH / m



IECEX Certificate of Conformity



Certificate No.: **IECEX BVS 21.0024X**
Annex
Page 2 of 1

Thermal parameters

Ambient temperature range / Temperature class / Surface temperature $-30\text{ }^{\circ}\text{C} \leq T_{\text{amb}} \leq 40\text{ }^{\circ}\text{C}$ (T6)
 $-30\text{ }^{\circ}\text{C} \leq T_{\text{amb}} \leq 70\text{ }^{\circ}\text{C}$ (T4 and dust)

Published by
Minebea Intec GmbH | Meiendorfer Strasse 205 A | 22145 Hamburg, Germany
Phone: +49.40.67960.303 | Email: info@minebea-intec.com
www.minebea-intec.com

